

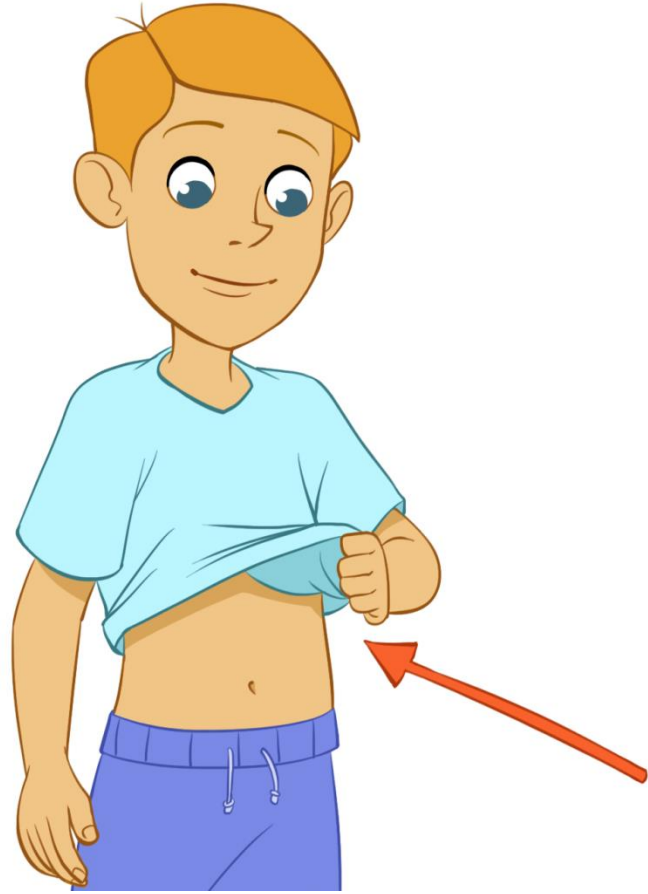



# inside

The baby grew \_\_\_\_\_  
Mom's belly.





# belly

\_\_\_\_\_ is another name  
for stomach.







eat

Henry needs to \_\_\_\_\_ .







# feed

Mom lets me \_\_\_\_\_  
my brother.





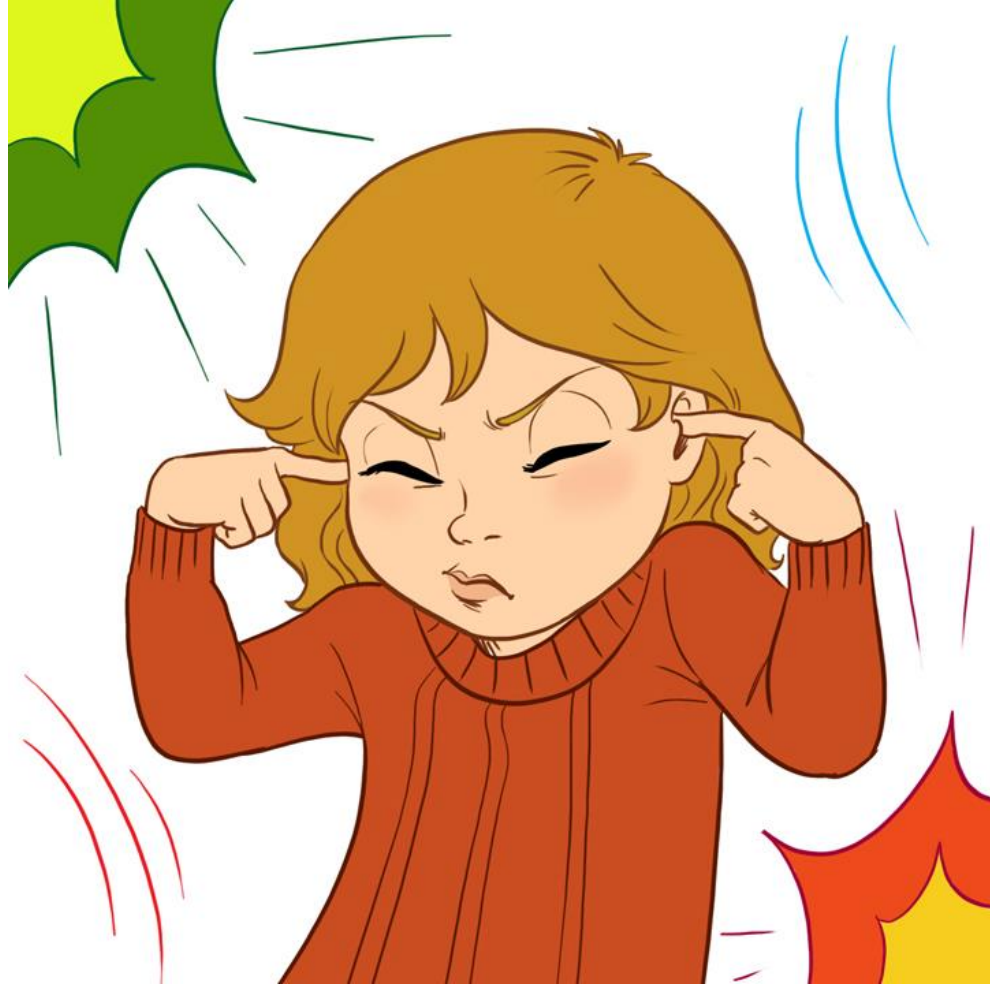



# noisy

Henry can be \_\_\_\_\_,  
but I love him.





# take care

I love \_\_\_\_\_ of Henry.







# hug

I \_\_\_\_\_ my mom every  
night before bed.





# siblings

We are \_\_\_\_\_.







# hurricane

\_\_\_\_\_ occur near the  
ocean.





# occur

The wedding is going to  
\_\_\_\_\_ at 6 p.m. tomorrow.

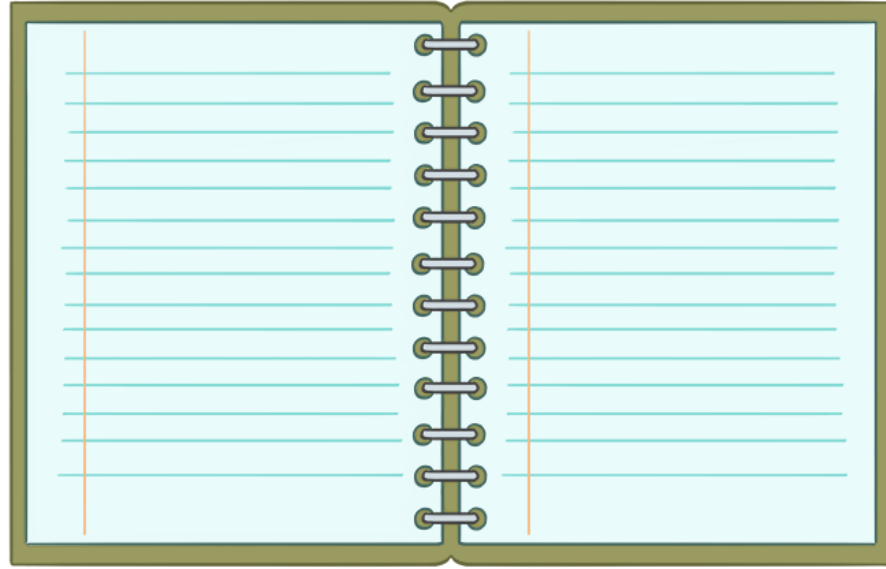



# near

The tree \_\_\_\_\_ my  
house is very tall.







# badly

After a hurricane, people  
\_\_\_\_\_ need help.







think

Mom \_\_\_\_\_ we should  
help out.

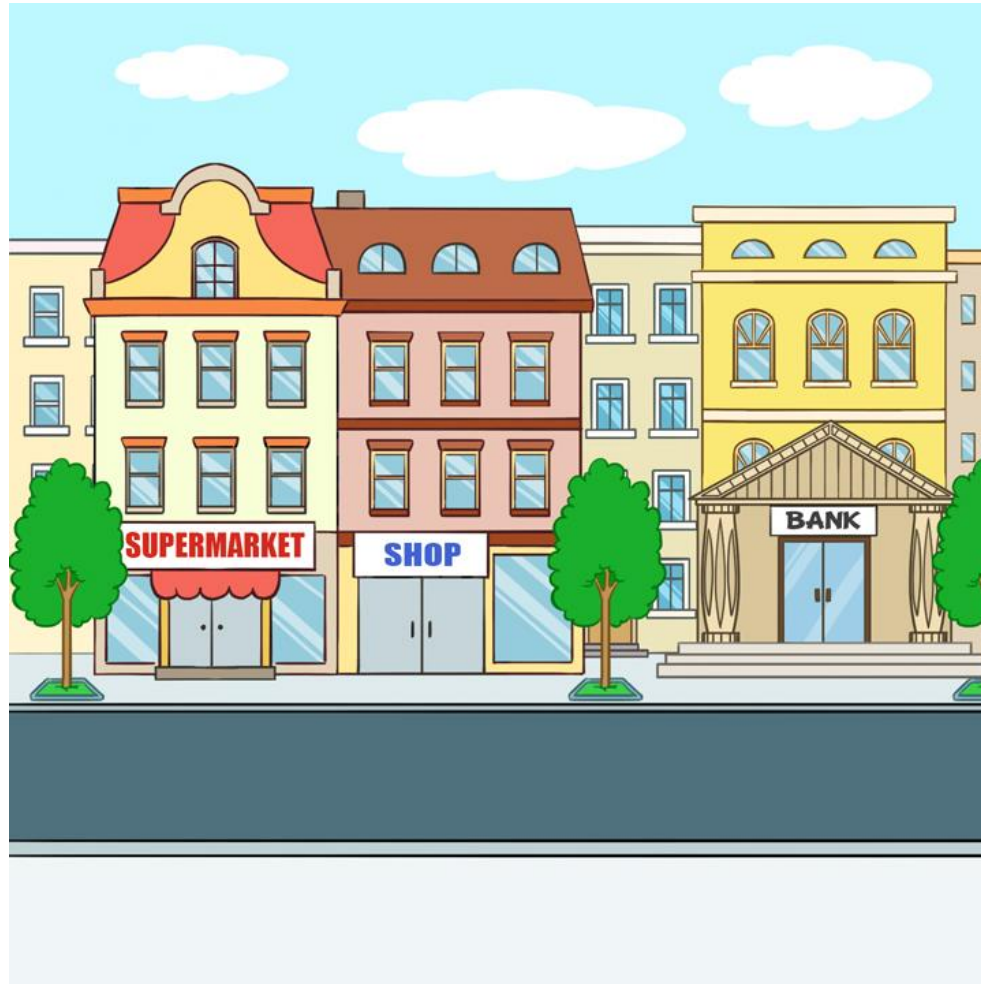



# town

We drive to a nearby

\_\_\_\_\_.





# aid

Because of the hurricane,  
people need food \_\_\_\_\_.







# volunteer

They always \_\_\_\_\_ to  
help.



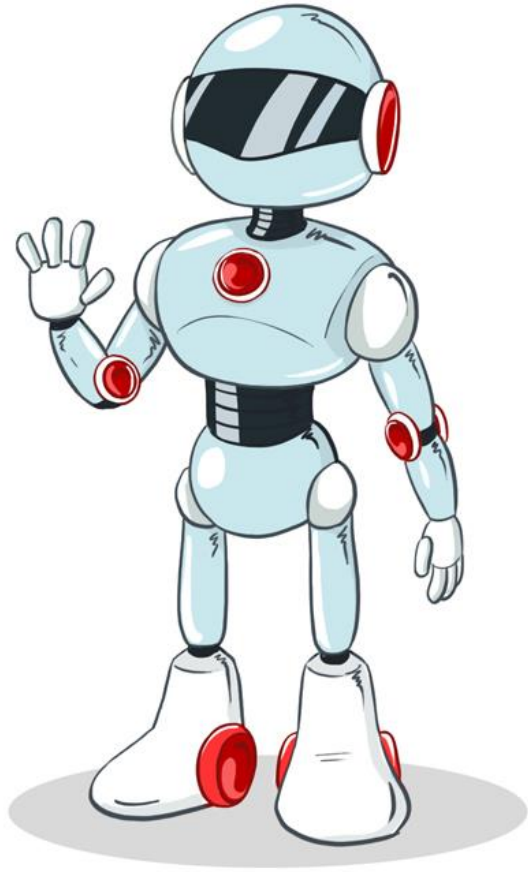



# robot

My friend Izzy likes to  
make \_\_\_\_\_.





# student

Each \_\_\_\_\_ makes a  
part.

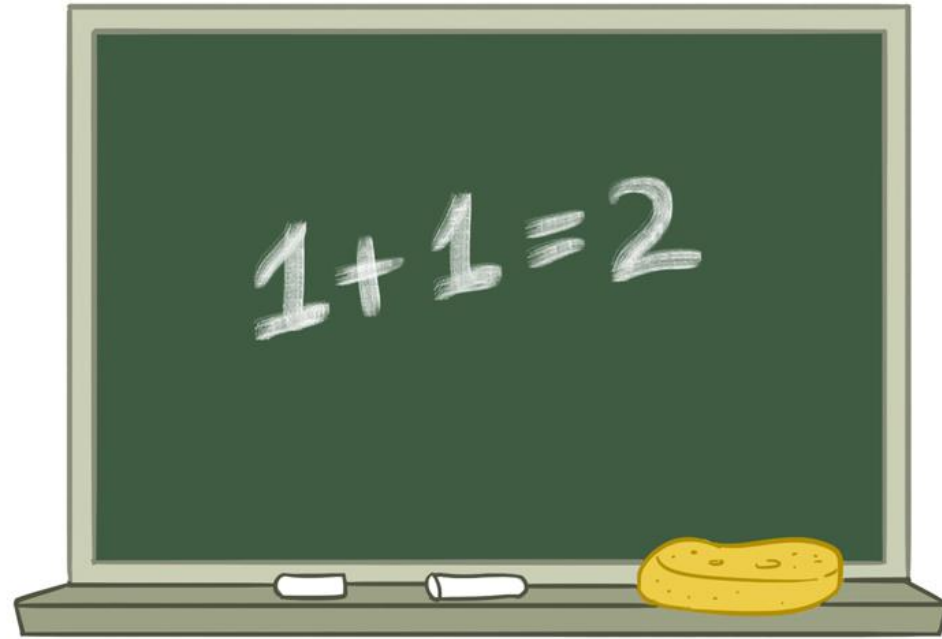



easy

The robots do \_\_\_\_\_  
jobs.



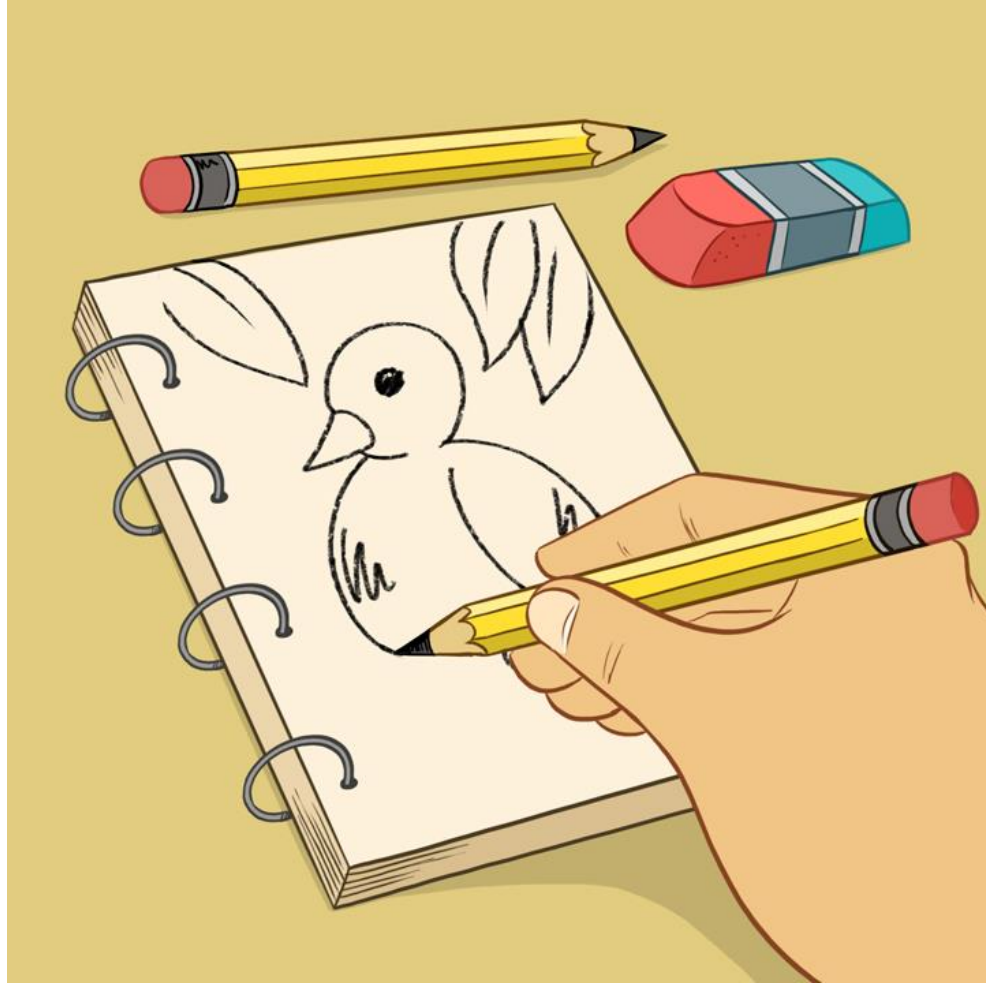



# draw

Another robot \_\_\_\_\_  
on paper.







# work

It sounds like hard

\_\_\_\_\_.





cool

Izzy says I will be a  
\_\_\_\_\_ group member.

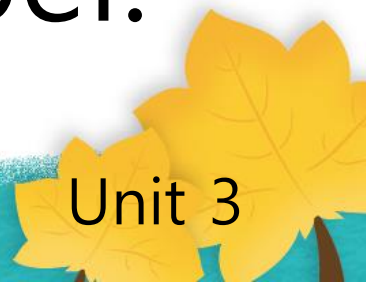

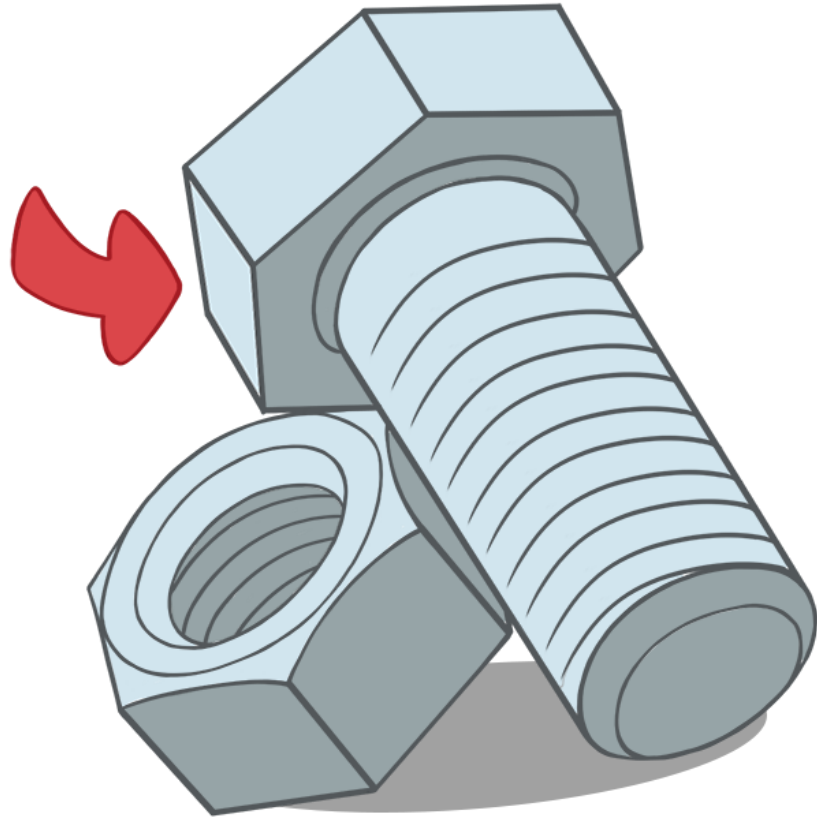



# bolt

There were many  
\_\_\_\_\_ in the box.



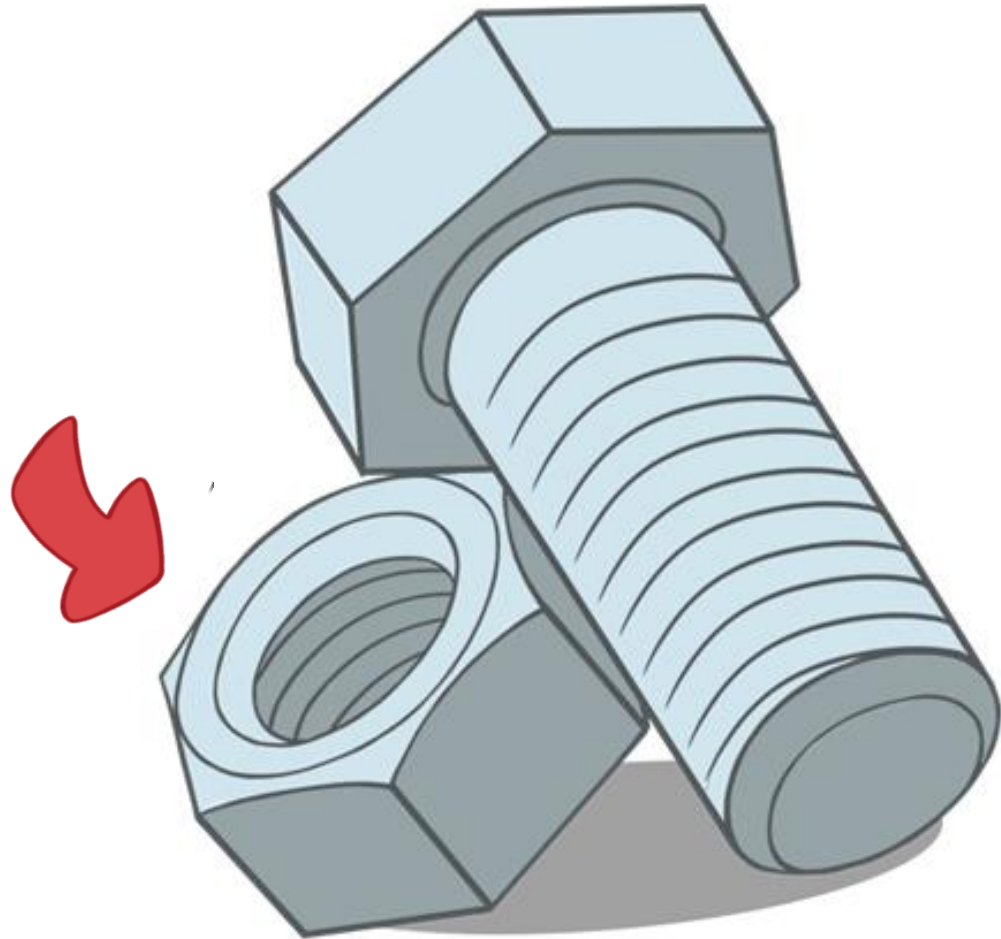



nut

The machine had many

\_\_\_\_\_.







# singer

Come see great \_\_\_\_\_,  
dancers, and actors.







actor

You can see a great  
\_\_\_\_\_ on the stage.





# miss

You don't want to  
\_\_\_\_\_ it!



10	11	12	13	14
17	18	19	20	21
24	25	26	27	28
31				

8	9	10	11	12	13	14
15	16	17	18	19	20	21
22	23	24	25	26	27	28
29						

8	9	10	11
15	16	17	18
22	23	24	25
29	30	31	

**APRIL**

**MAY**

**JUN**

3	4	5	6	7
10	11	12	13	14
17	18	19	20	21
24	25	26	27	28

1	2	3	4	5	6	7
8	9	10	11	12	13	14
15	16	17	18	19	20	21
22	23	24	25	26	27	28
29	30	31				

1	2	3	4
8	9	10	11
15	16	17	18
22	23	24	25
29	30		

**JULY**

**AUGUST**

**SEPTE**

3	4	5	6	7
10	11	12	13	14

1	2	3	4	5	6	7
8	9	10	11	12	13	14

1	2	3	4
8	9	10	11





# May

My birthday is on  
\_\_\_\_\_ 2nd.









# invite

I \_\_\_\_\_ all of my  
friends to the show.





# ticket

\_\_\_\_\_ for kids are \$5.





# cast a spell

The wizard \_\_\_\_\_ on  
the frog.





# mysterious

I love to read \_\_\_\_\_  
stories.







# drop

I am a \_\_\_\_\_ of water.



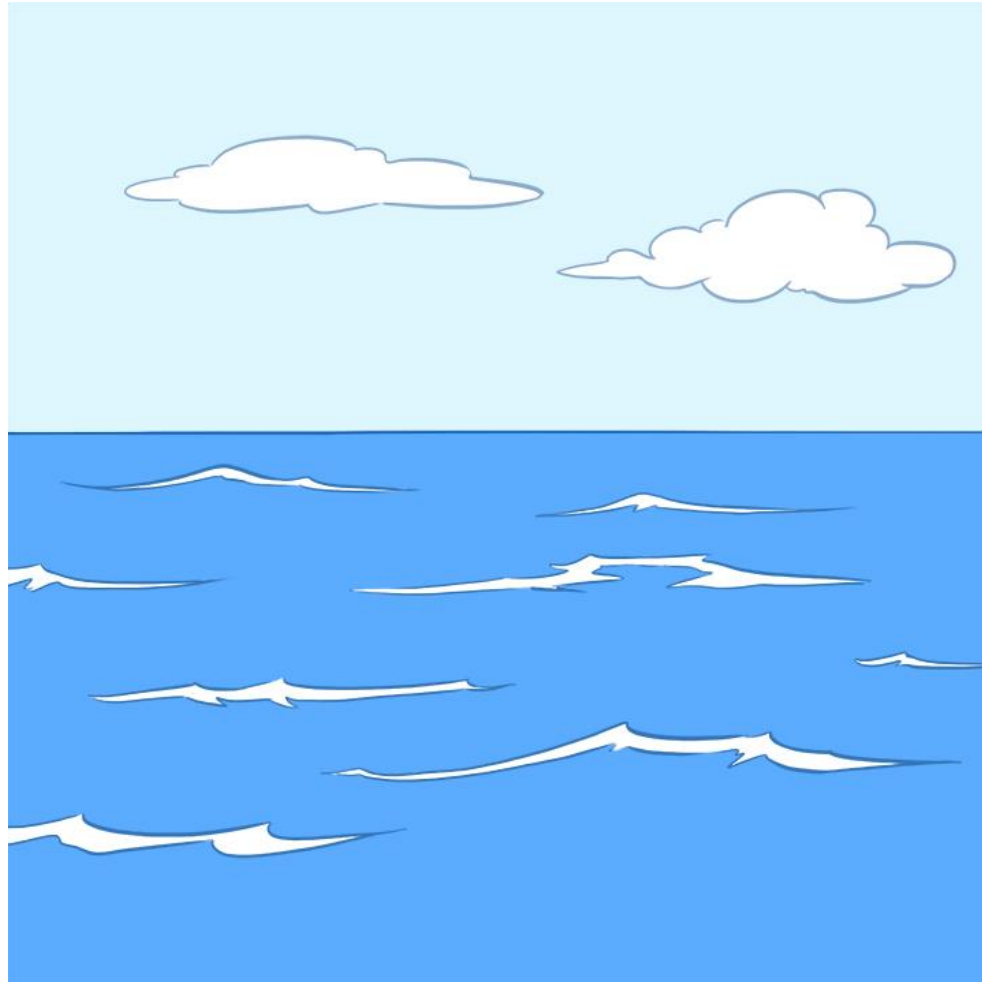



# ocean

I like to live in the

\_\_\_\_\_.







# sunny

Then, on a \_\_\_\_\_ day, I  
change!



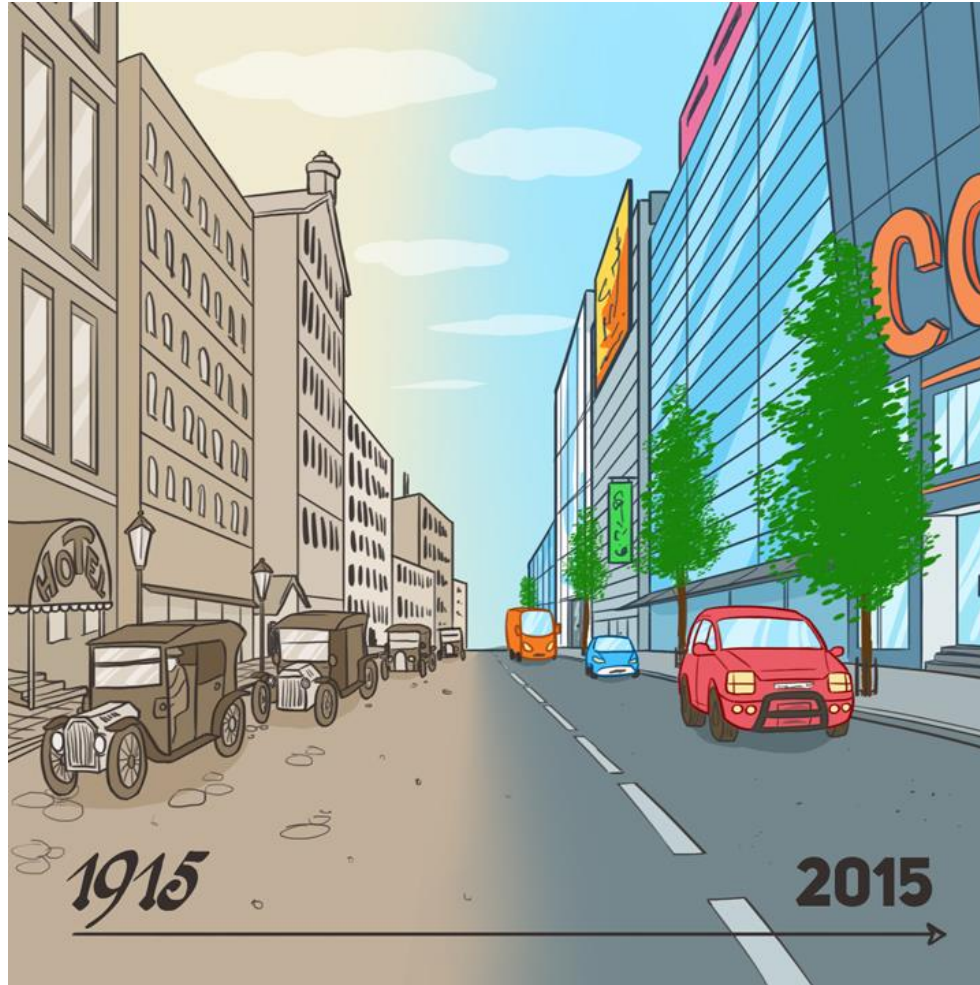



# change

Octopuses can \_\_\_\_\_  
color.



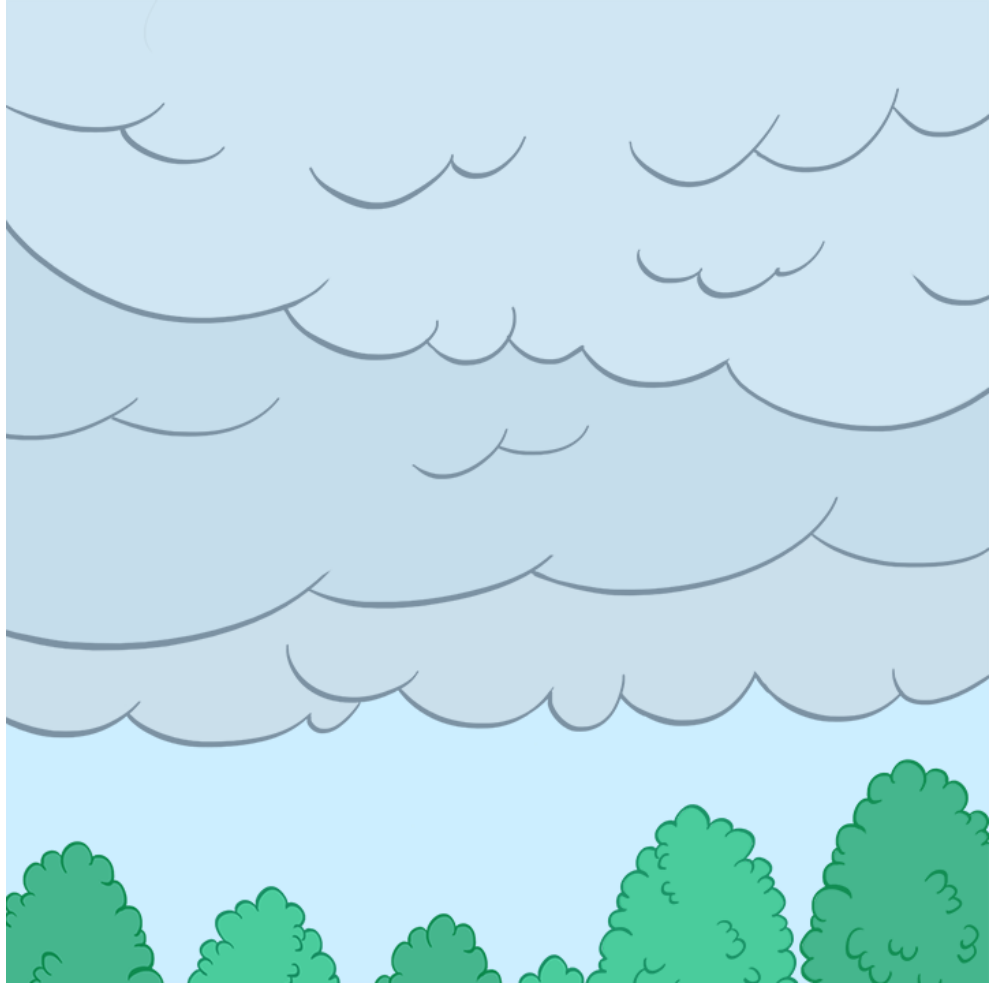



# cloudy

We can make the sky

\_\_\_\_\_.





# become

We \_\_\_\_\_ rain, and we  
fall from the sky.





# rainy

The plants love this  
\_\_\_\_\_ day.





# snowy

I love to play outside on  
\_\_\_\_\_ days.









# present

"I have a \_\_\_\_\_ for  
you," Grandpa said.

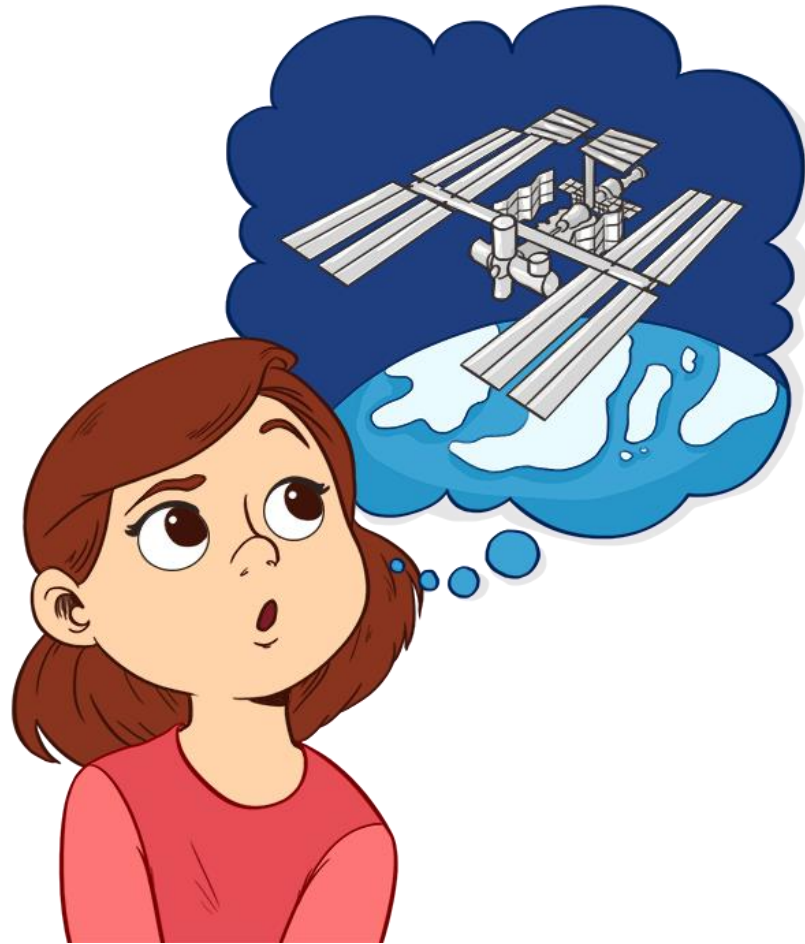



# wonder

I \_\_\_\_\_ what the  
present was.





# blow

Their coach shouts,  
" \_\_\_\_\_ the whistle!"





# instrument

Grandpa blew the long

\_\_\_\_\_.







ready

I was \_\_\_\_\_ for my first  
concert.





# proud

Grandpa was \_\_\_\_\_ of  
me.





# play music

We \_\_\_\_\_ together  
every day.





# audience

The \_\_\_\_\_ loved the  
concert.



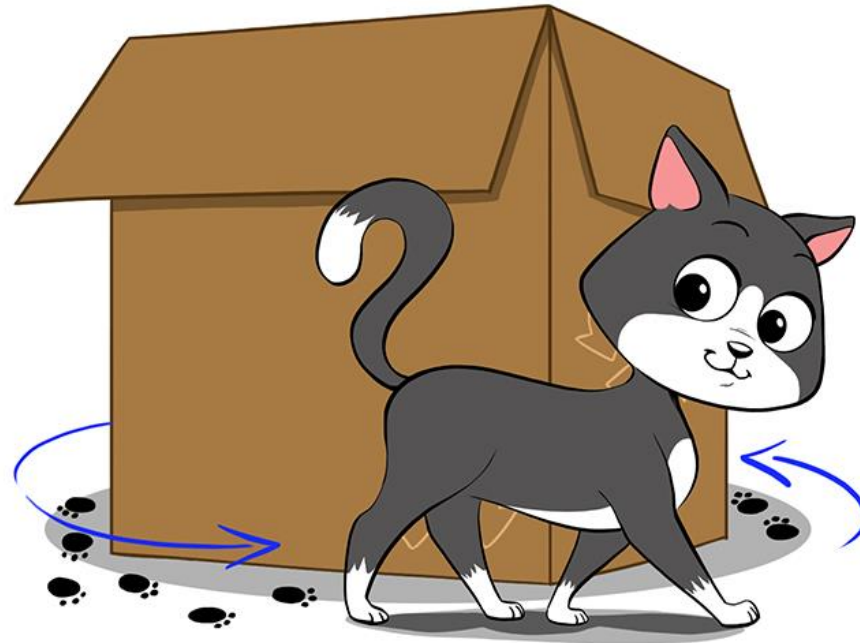



# around

The cat walked the  
\_\_\_\_\_ box.

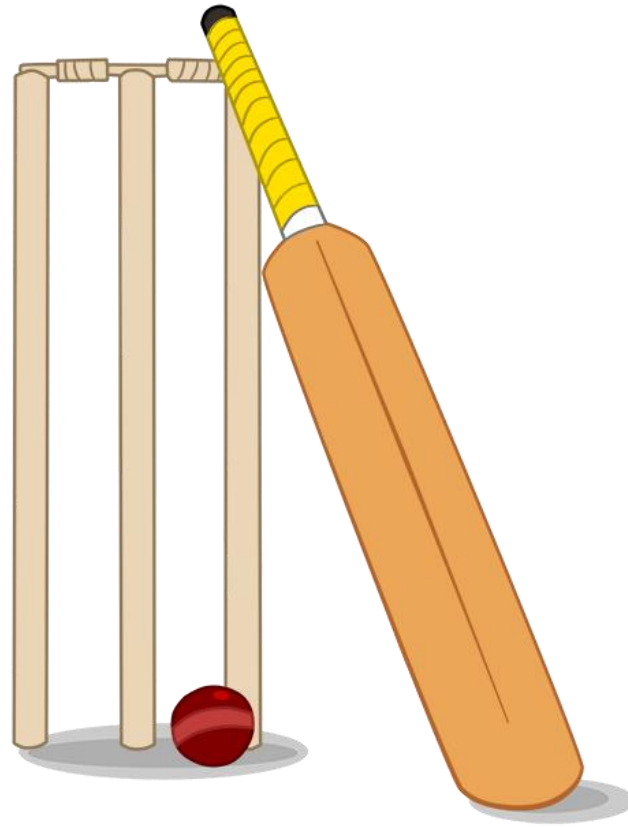



# cricket

Some people around the  
world love \_\_\_\_\_.





# team

\_\_\_\_\_ of eleven play  
on a field.

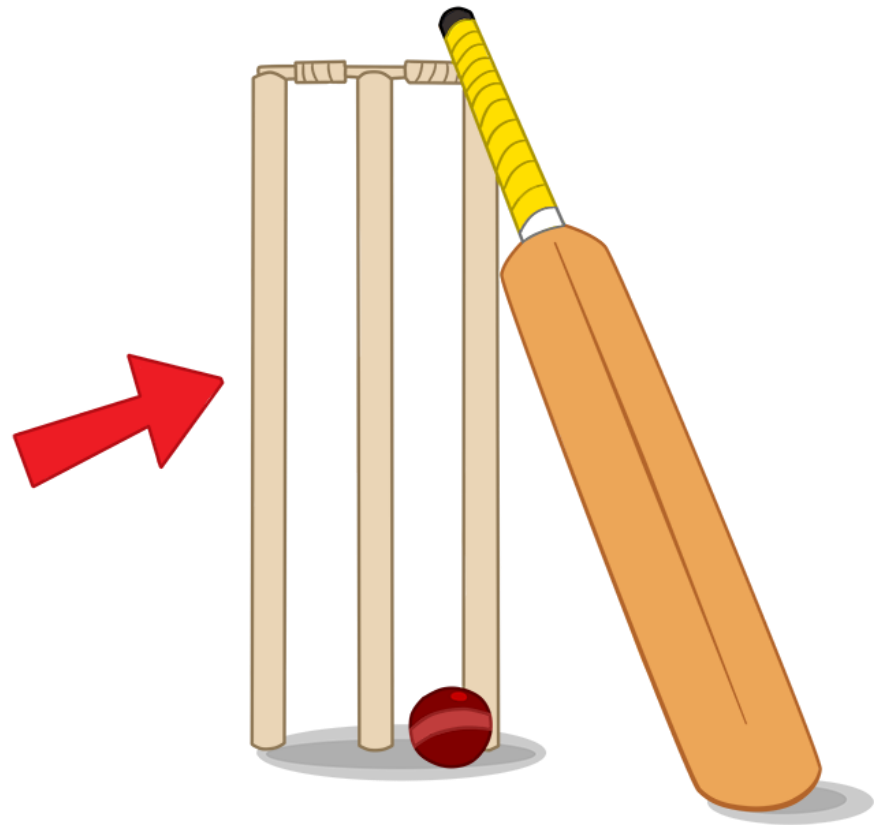



# stick

There are \_\_\_\_\_ on  
each end.









# hit

If the ball \_\_\_\_\_ the sticks, Player Two is out.

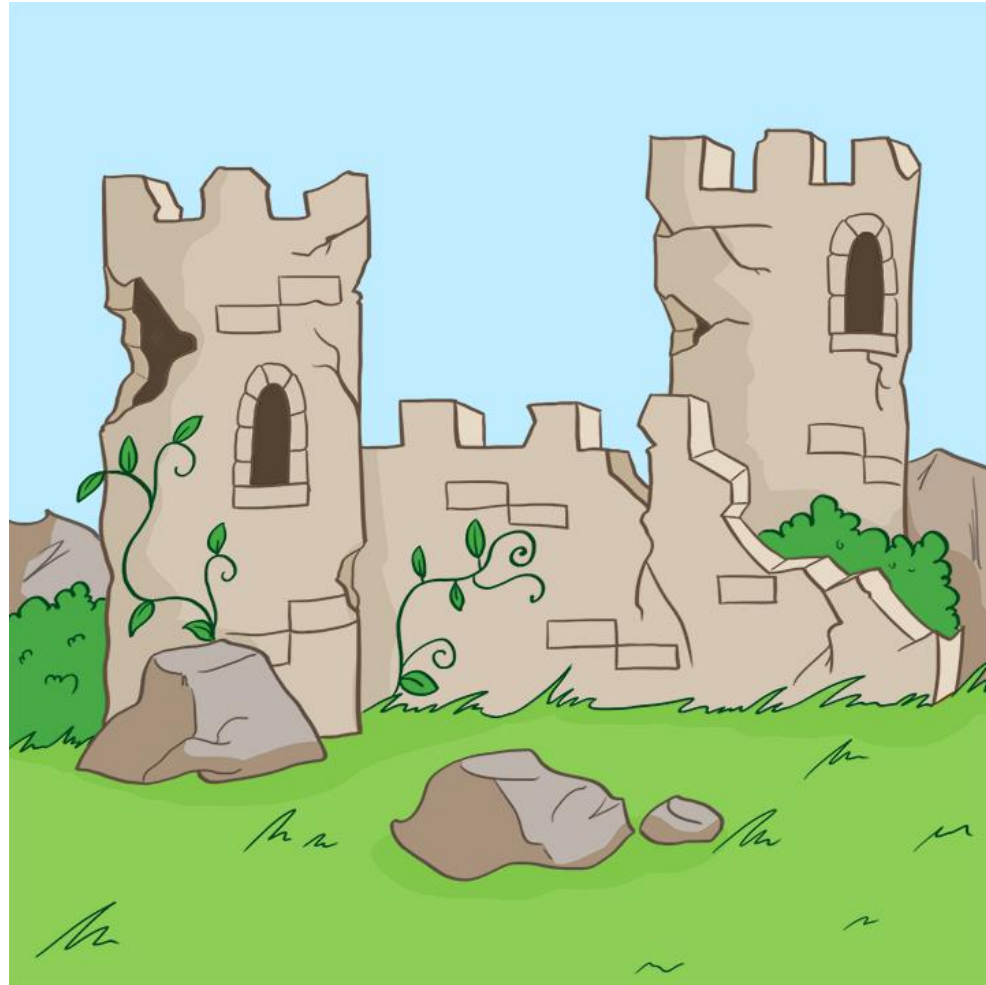



# last

A cricket match can  
\_\_\_\_\_ for five days!







# bat

A \_\_\_\_\_ is used to  
play cricket.

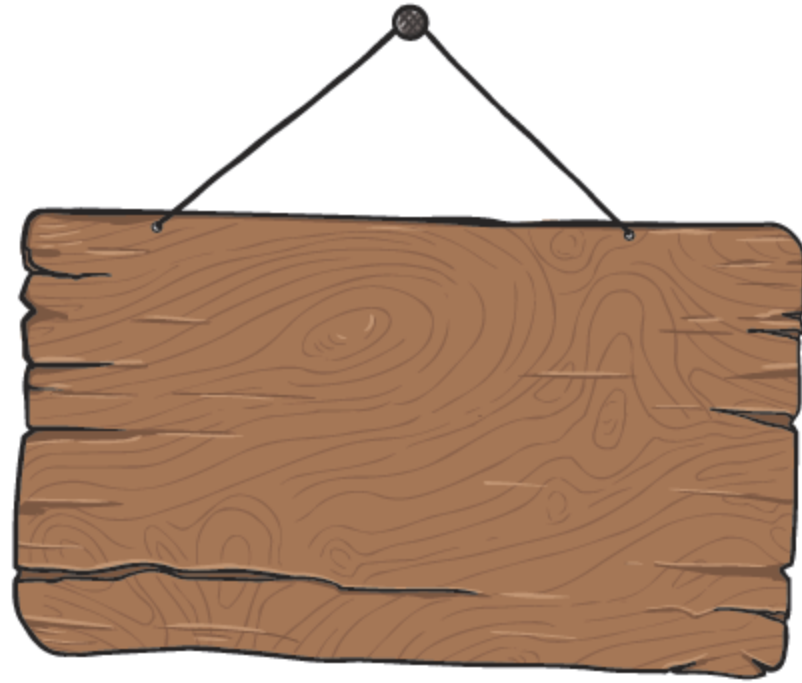



# wooden

We play cricket with a  
\_\_\_\_\_ bat.







piece

LEGO didn't invent their  
building \_\_\_\_\_.





# wheel

LEGO is the world's  
biggest \_\_\_\_\_ maker.







# kilogram

A LEGO piece can hold up  
to 432 \_\_\_\_\_.





# break

A LEGO piece doesn't  
\_\_\_\_\_ easily.



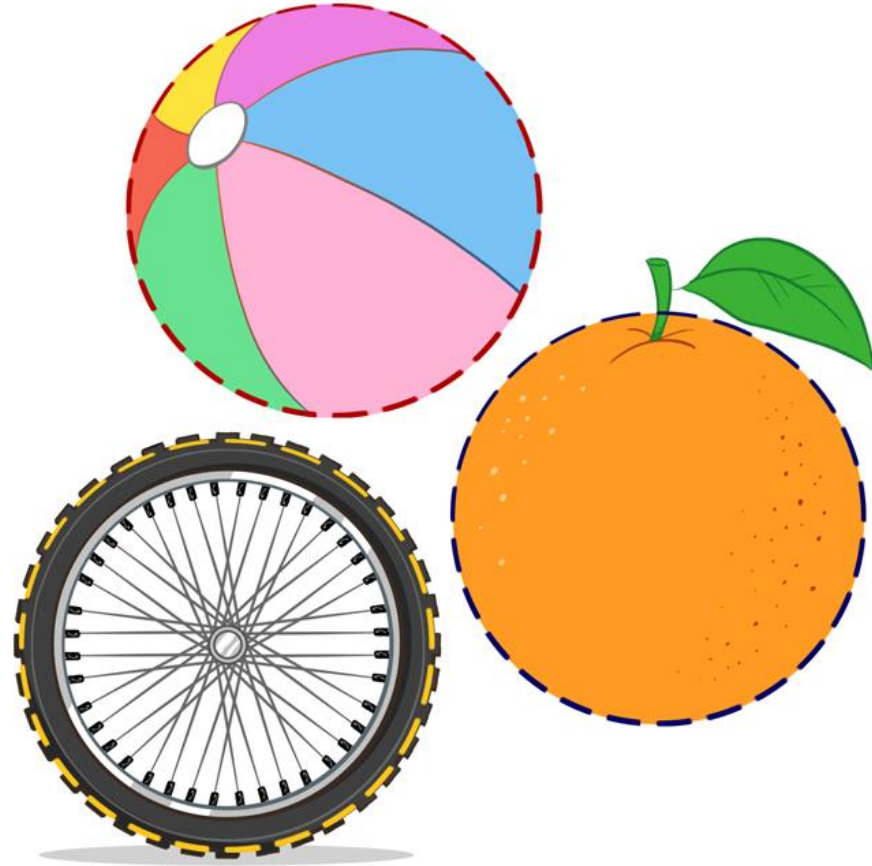



# round

LEGO figures have \_\_\_\_\_  
holes in their heads.





# hurt

Holes are there so that you  
don't \_\_\_\_\_ yourself.



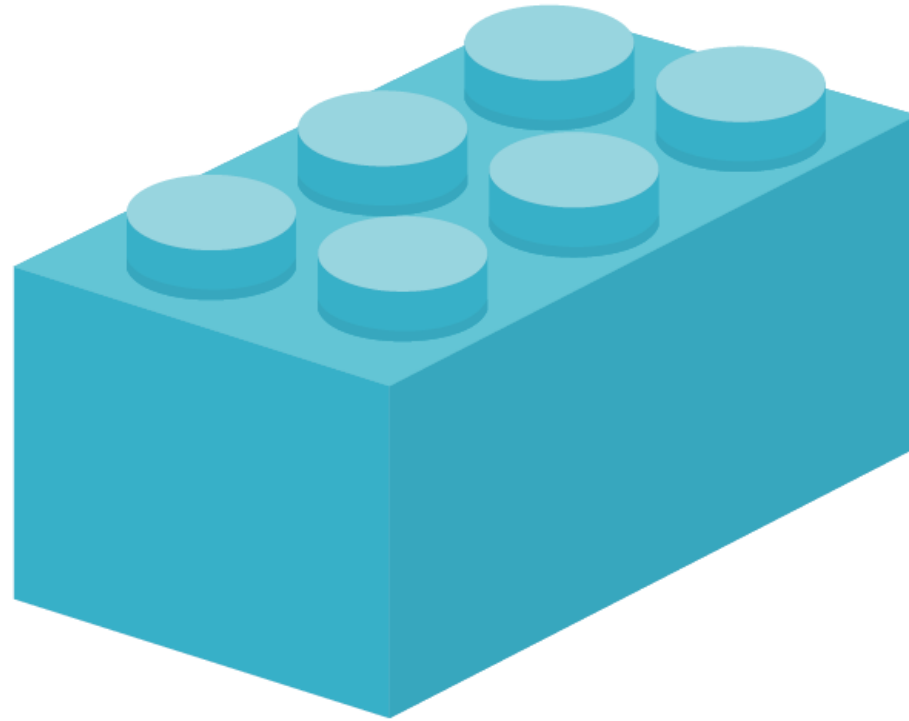



# brick

I have many LEGO

\_\_\_\_\_.

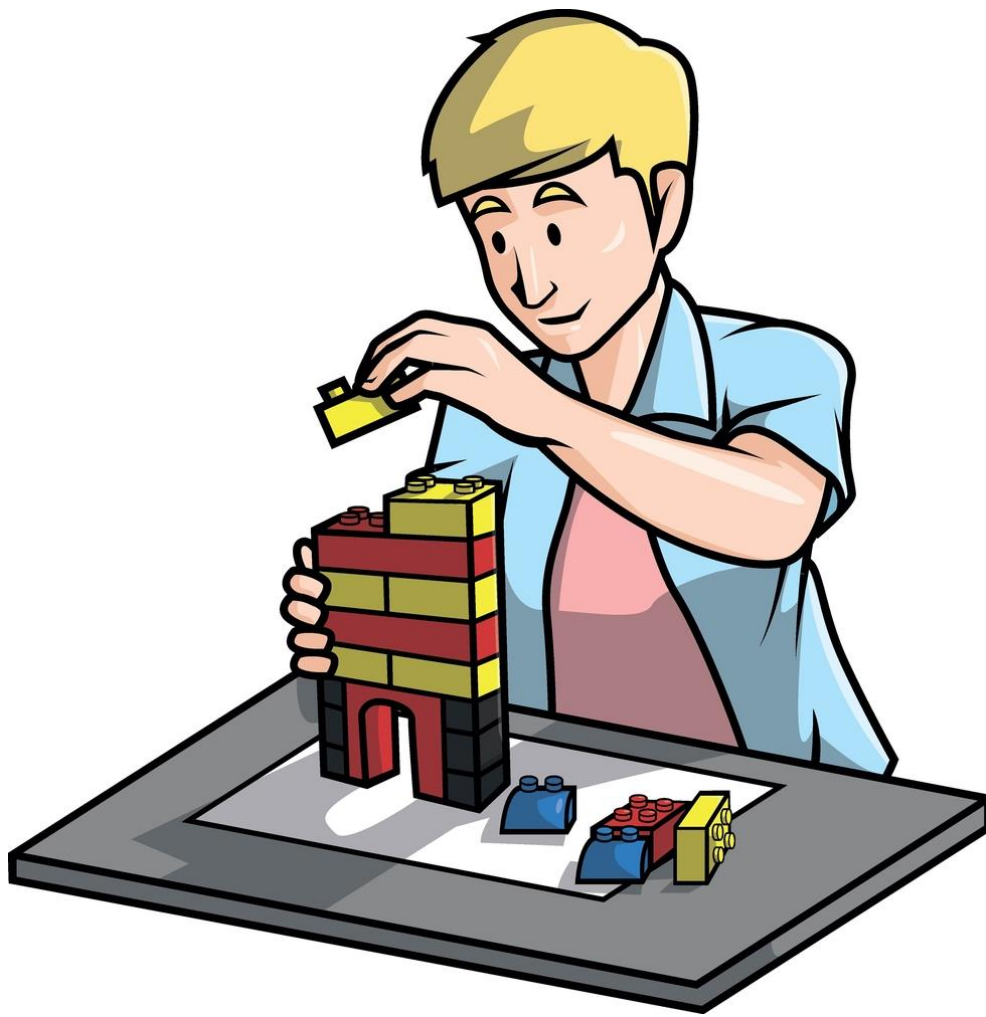



# build

You can \_\_\_\_\_ many things with LEGO pieces.







# evening

In the \_\_\_\_\_, you can  
see stars.





# dark

One evening, Jim looks up  
at the \_\_\_\_\_ sky.







see

Jim \_\_\_\_\_ the sky full  
of stars.



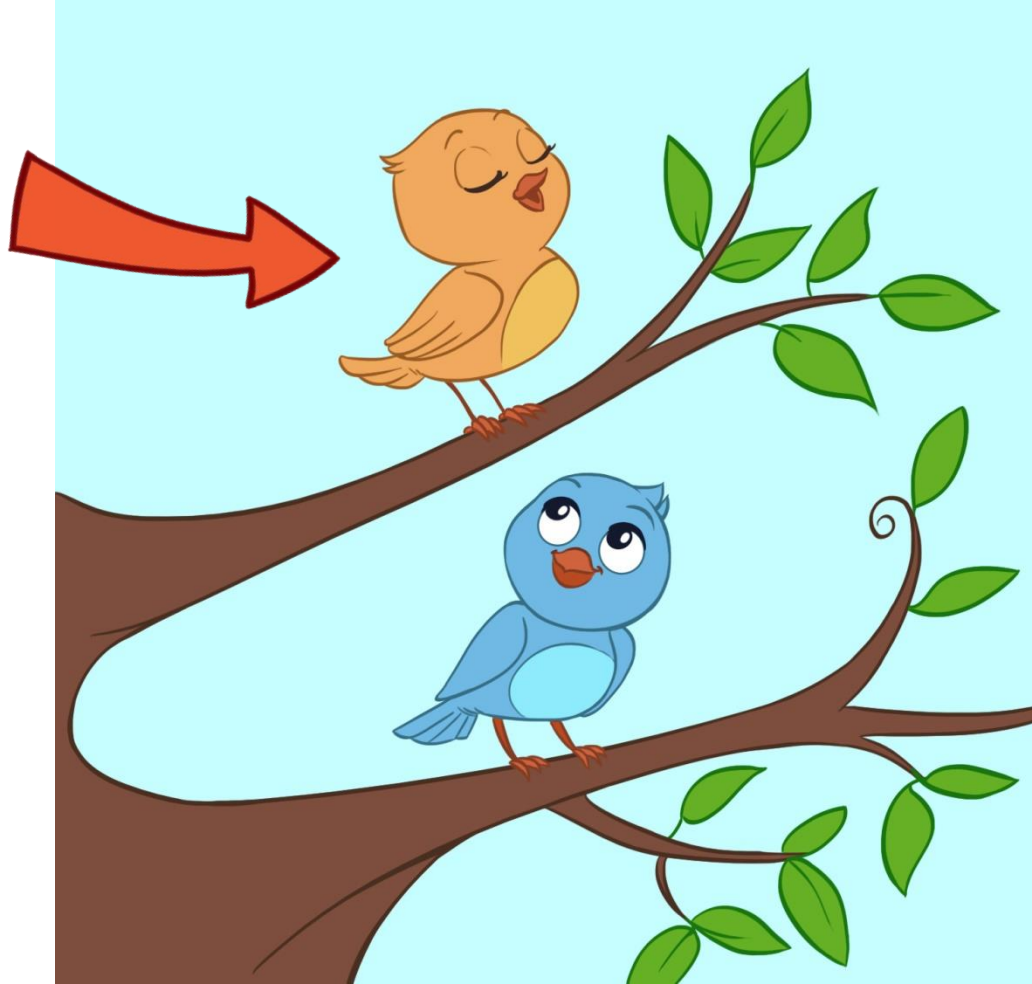



# above

Jim sees the stars

\_\_\_\_\_.









# beautiful

"Yes, the stars are  
\_\_\_\_\_, " Jim says.

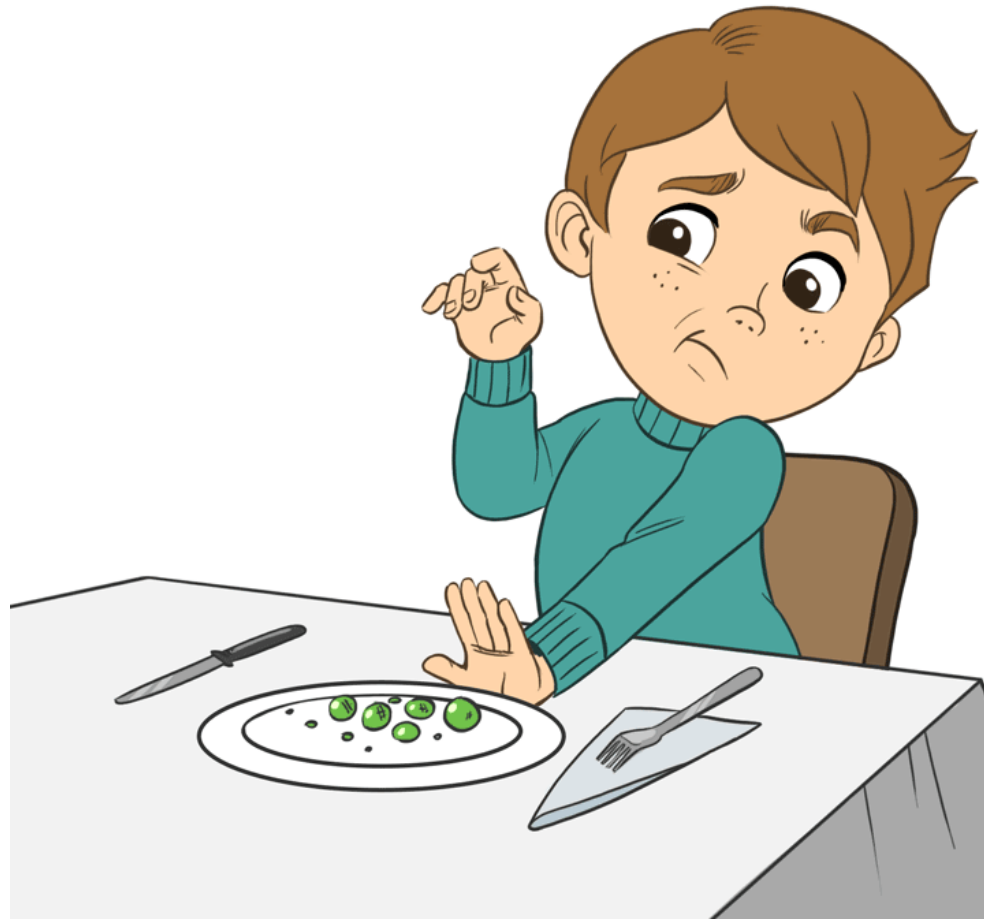



# away

Put the peas \_\_\_\_\_.





# old

Dad says the stars are far  
away and \_\_\_\_\_.





# young

Jim is \_\_\_\_\_.







# shout

"There's a fire!" he

\_\_\_\_\_.





# firefighter

When the \_\_\_\_\_  
arrived, Cara went to Steve.





cry

“Patches is inside somewhere,”  
Steve \_\_\_\_\_.







# rush

Cara \_\_\_\_\_ inside and  
carried Patches to the window.







# photographer

A \_\_\_\_\_ took their  
pictures.





# job

“That’s our \_\_\_\_\_,”  
said Walter and Cara.





# dangerous

It's \_\_\_\_\_ to walk on  
an old bridge.





# rescue

The firefighters \_\_\_\_\_ the child from the burning building.







# hobby

My brother and I have a

\_\_\_\_\_.





# camp

We like to \_\_\_\_\_.



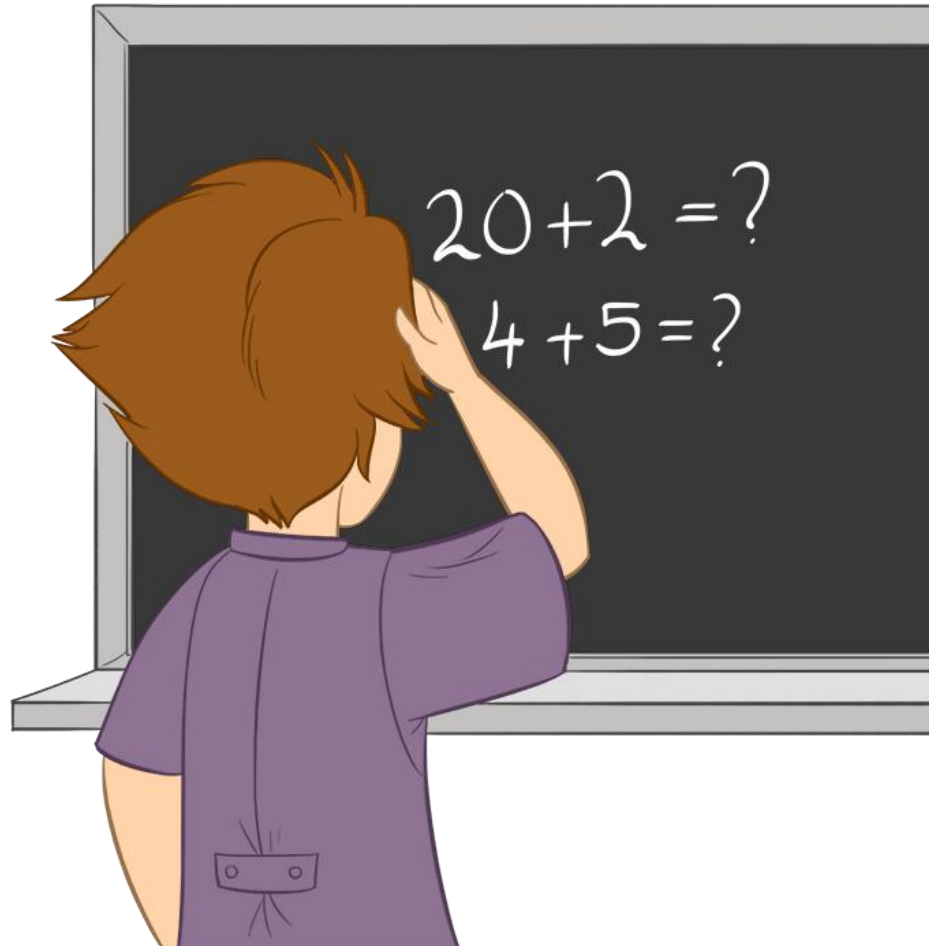



# problem

“We have a \_\_\_\_\_!”  
I shouted.





# lose

I \_\_\_\_\_ the map.









# mad

My brother was not  
\_\_\_\_\_ at me.





# smartphone

My brother had his

\_\_\_\_\_.





# indoor

I go swimming in \_\_\_\_\_  
pools in the winter.





# outdoor

We wanted an \_\_\_\_\_  
party, but it's raining today.







# plate

Yuki's mom put \_\_\_\_\_  
on the table.





# begin

Yuki \_\_\_\_\_ eating with  
long, thin sticks.

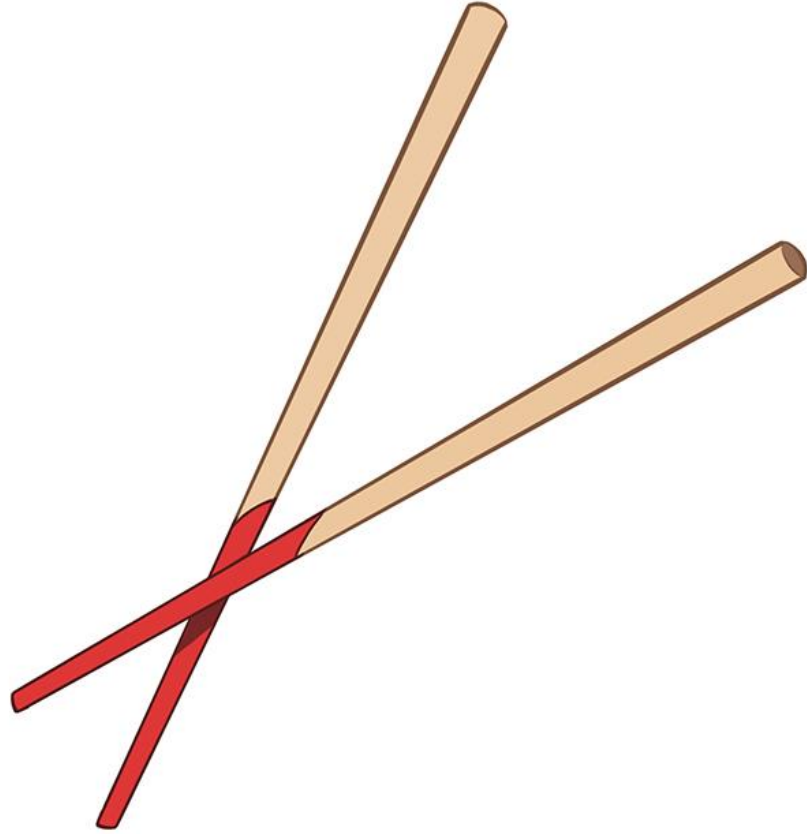



# chopsticks

\_\_\_\_\_ are thin sticks.





# sadly

"I can't use chopsticks,"  
Pari said \_\_\_\_\_.







# fork

"Do you use \_\_\_\_\_ in your country?" Gio asked Pari.







rice

Pari made a ball of  
\_\_\_\_\_ with her hand.







chew

The boy happily \_\_\_\_\_  
the pasta.

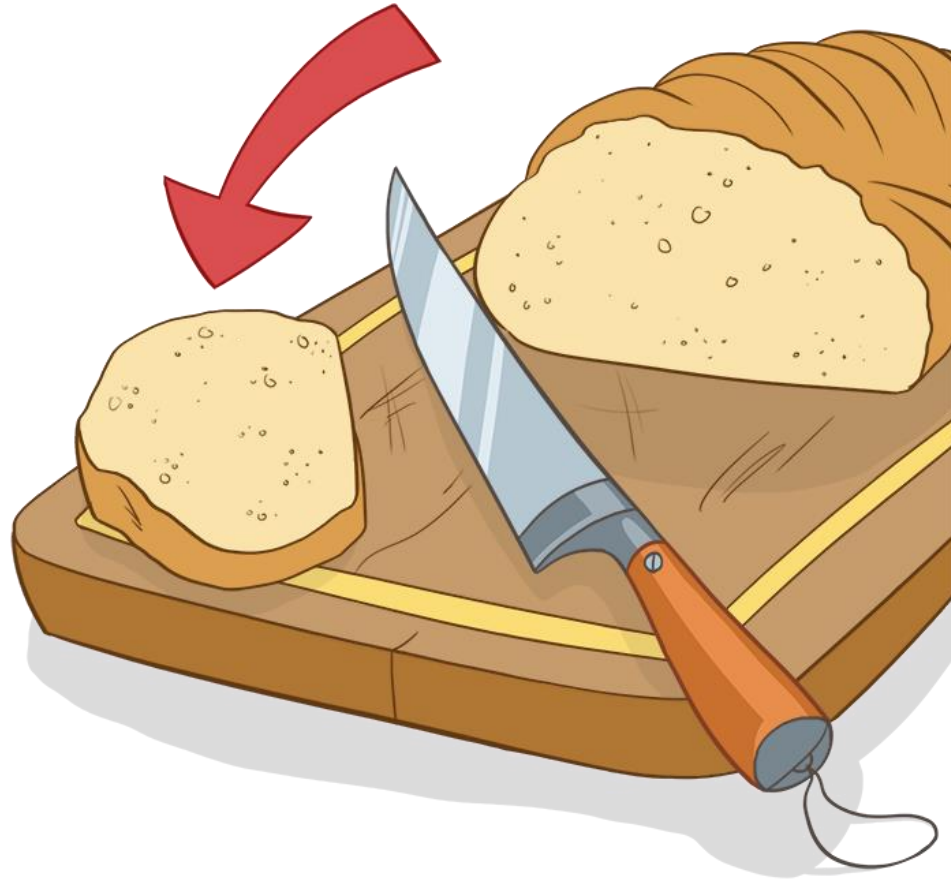



# slice

Use this knife to \_\_\_\_\_  
the bread.





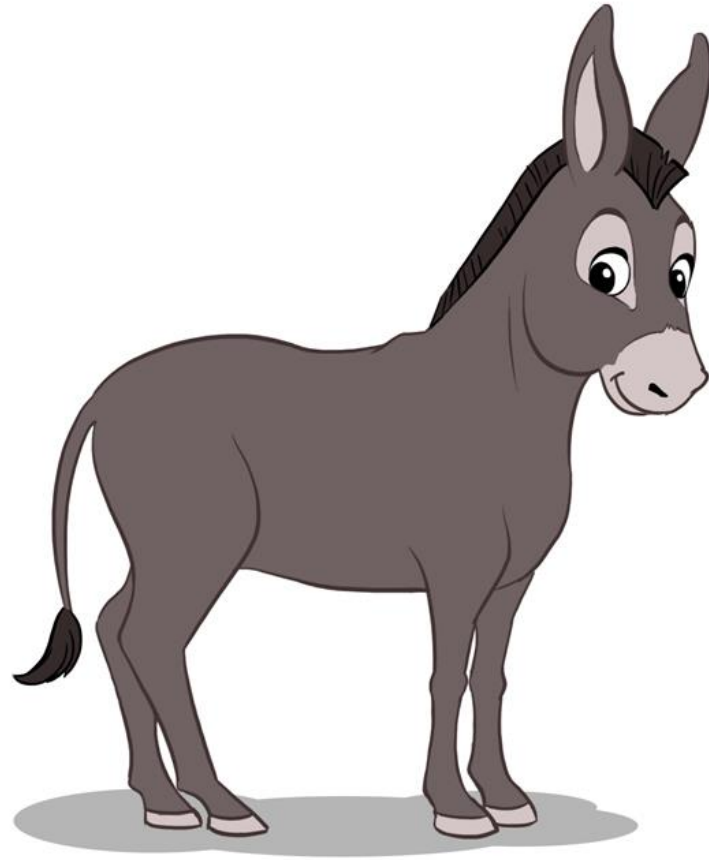



# donkey

Fox and \_\_\_\_\_ were  
walking in the desert.





# dinner

You will have donkey for

\_\_\_\_\_.





# quietly

“Let me go,” Fox said to  
Lion \_\_\_\_\_.





# agree

Lion \_\_\_\_\_ to let the  
fox go.









# follow

Donkey \_\_\_\_\_ Fox.

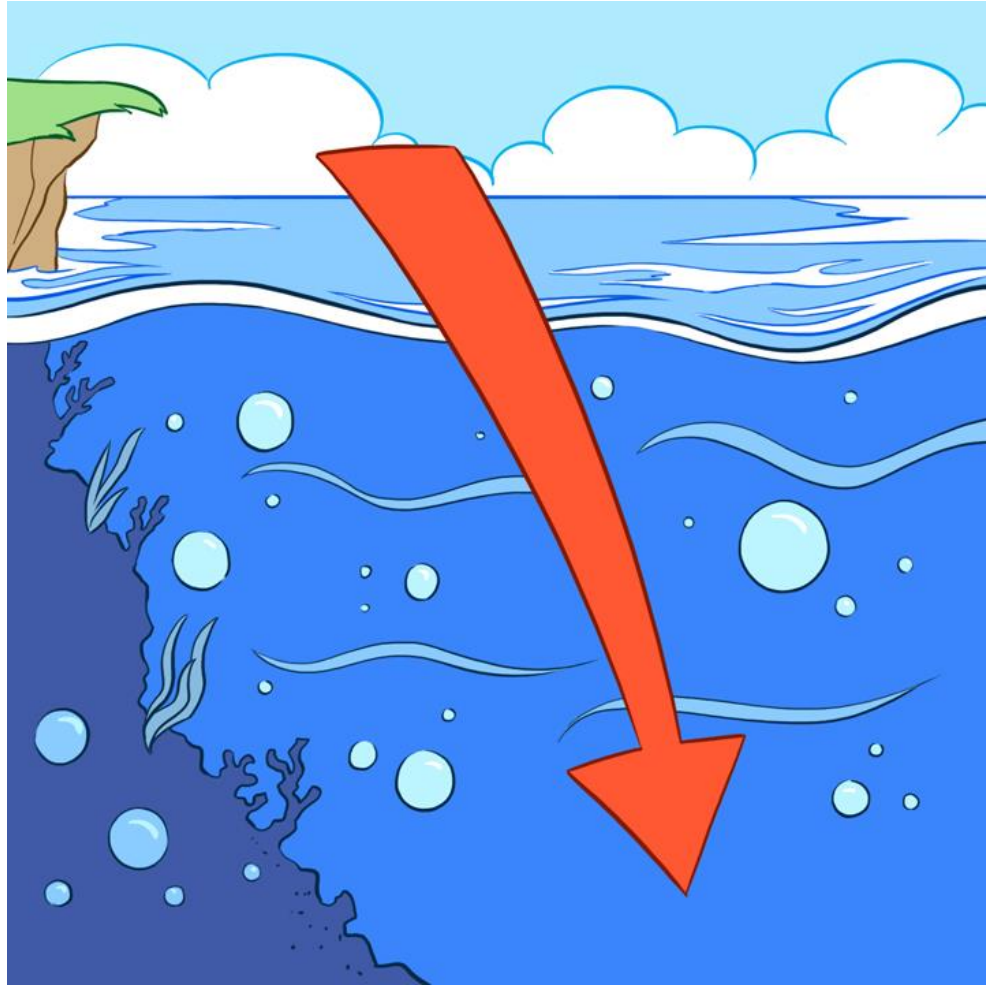



# deep

He fell into a \_\_\_\_\_  
hole .





# crater

The old \_\_\_\_\_ had  
water in it.



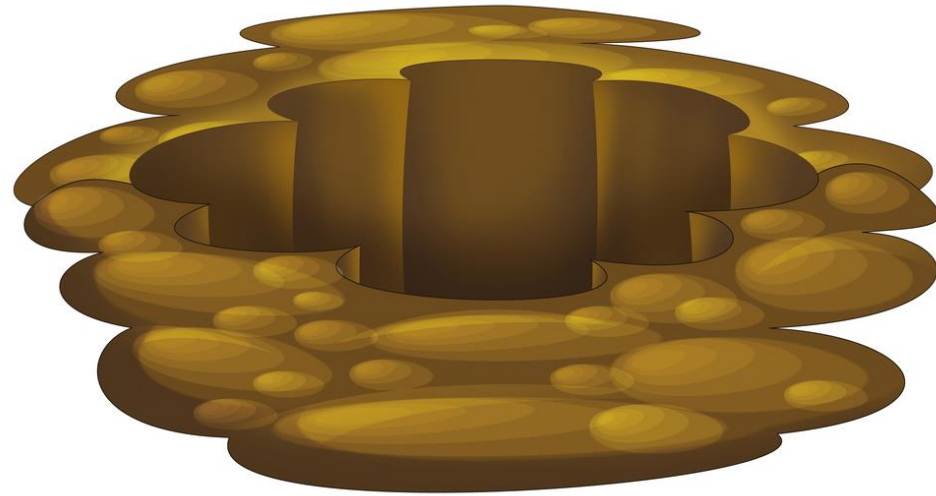



pit

The rabbit fell into a

\_\_\_\_\_.



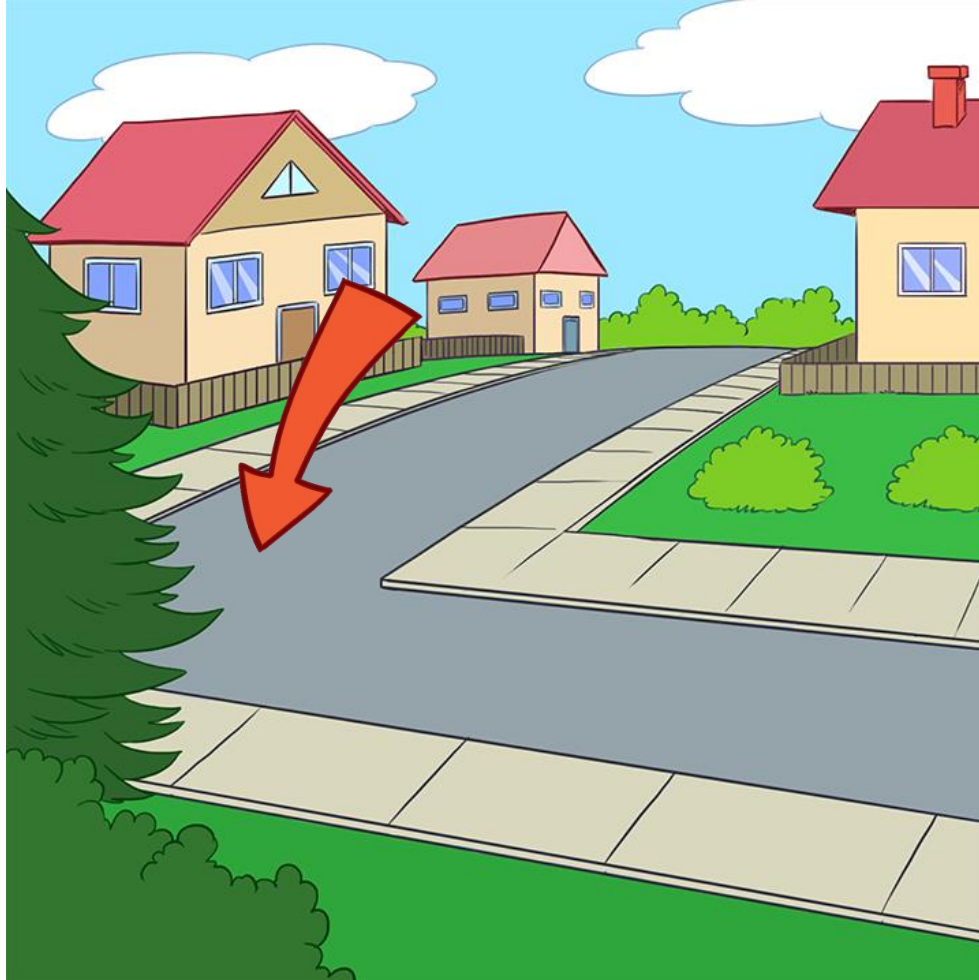



# corner

Dad and Billy walk to the

\_\_\_\_\_.



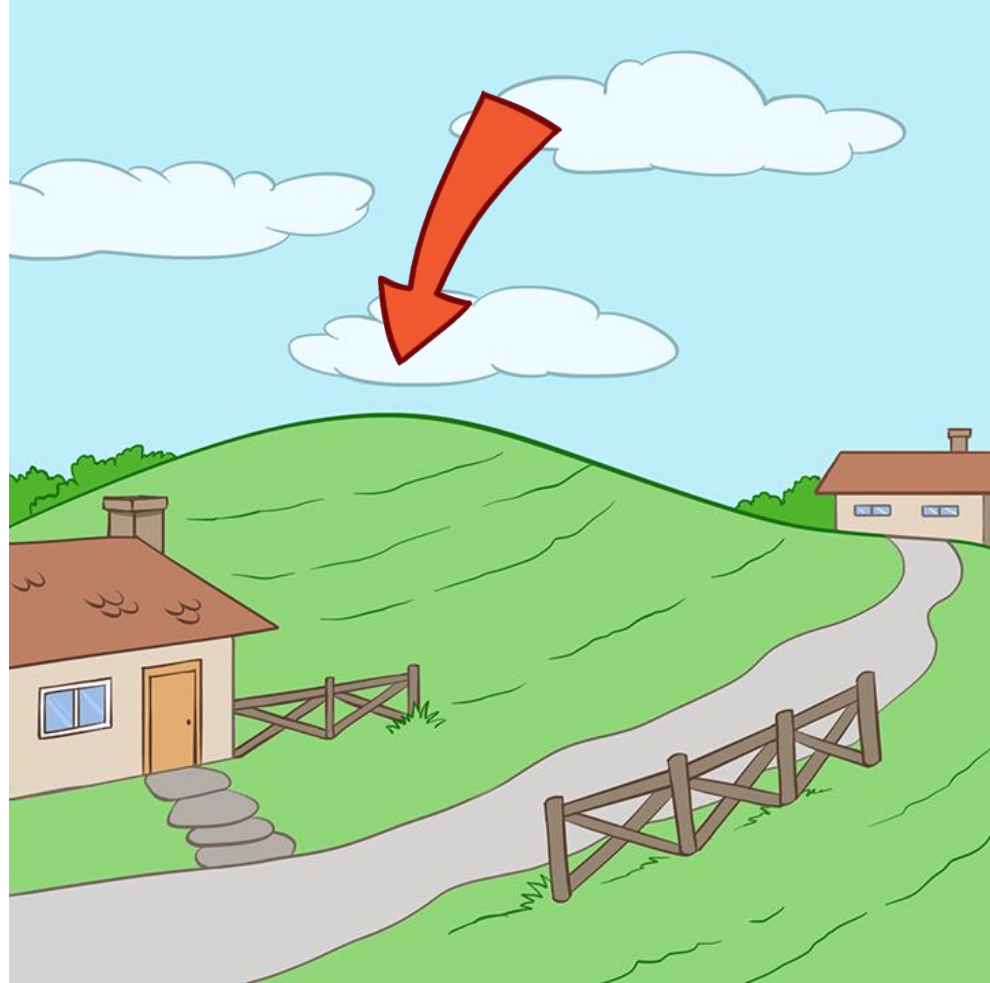



hill

The ball is by the

\_\_\_\_\_.







# terrible

He hears a \_\_\_\_\_  
sound.

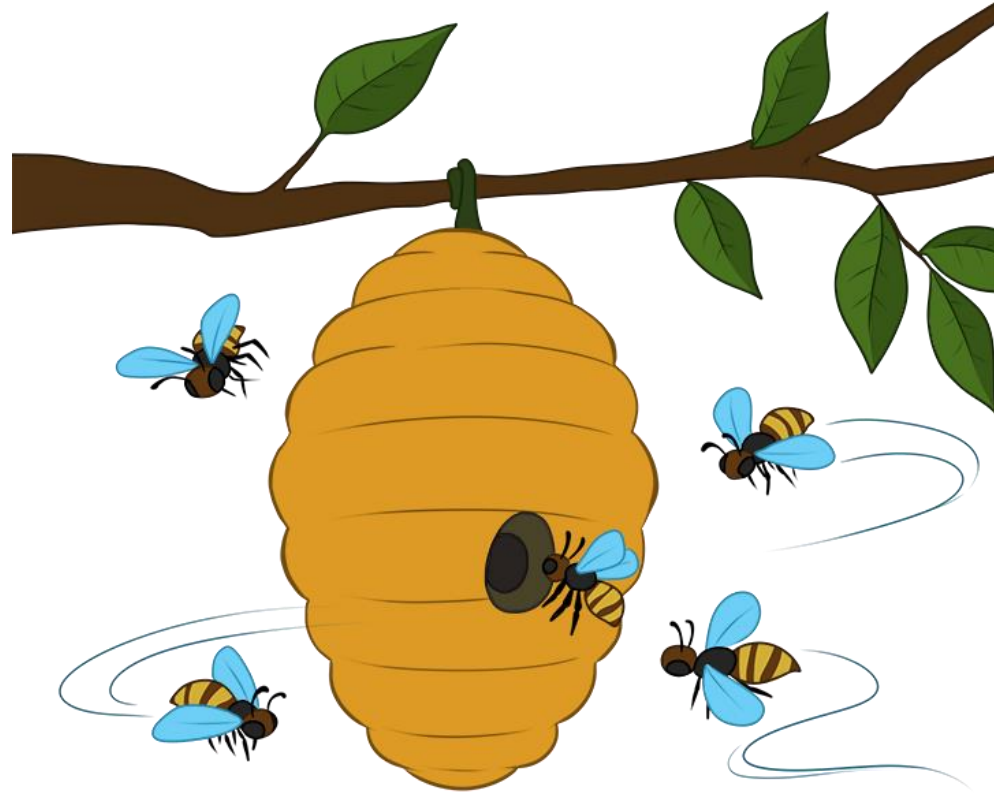



# beehive

The holes in the \_\_\_\_\_  
are hexagons.



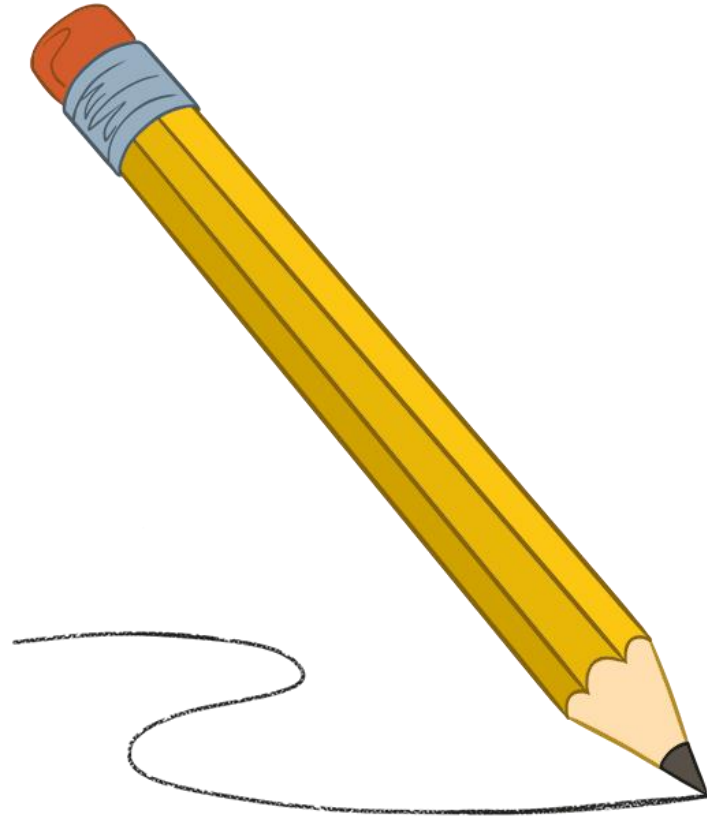



# pencil

My \_\_\_\_\_ is a hexagon,  
too!







# everywhere

Hexagons are \_\_\_\_\_!

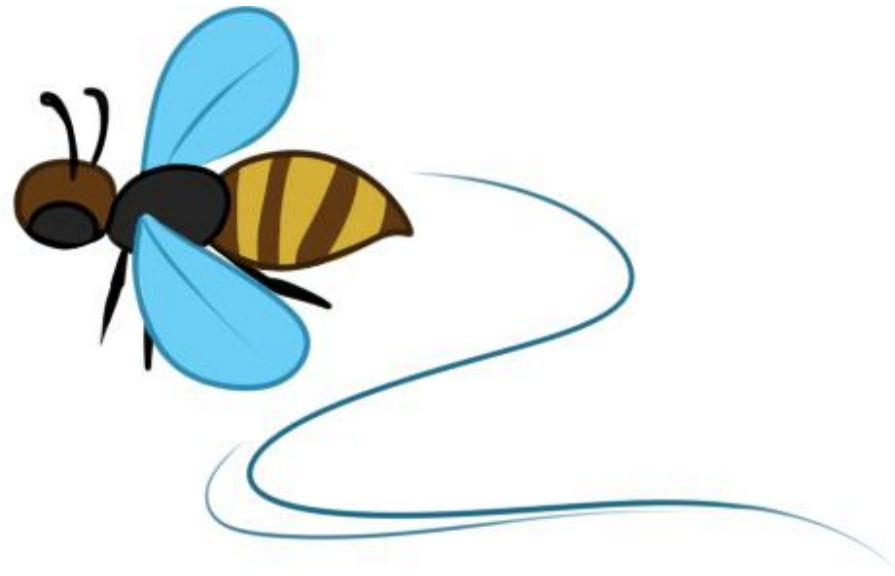



# buzz

The bees \_\_\_\_\_ next to  
the flowers.







# honeycomb

This golden \_\_\_\_\_ is a  
sweet treat for kids.







soap

\_\_\_\_\_ is important.







# unhealthy

Many soaps have  
\_\_\_\_\_ things in them.





# choose

Some people \_\_\_\_\_ to  
make soap at home.





# a few

You just need a bottle of oil  
and \_\_\_\_\_ other things.







# natural

This kind of soap is

\_\_\_\_\_.

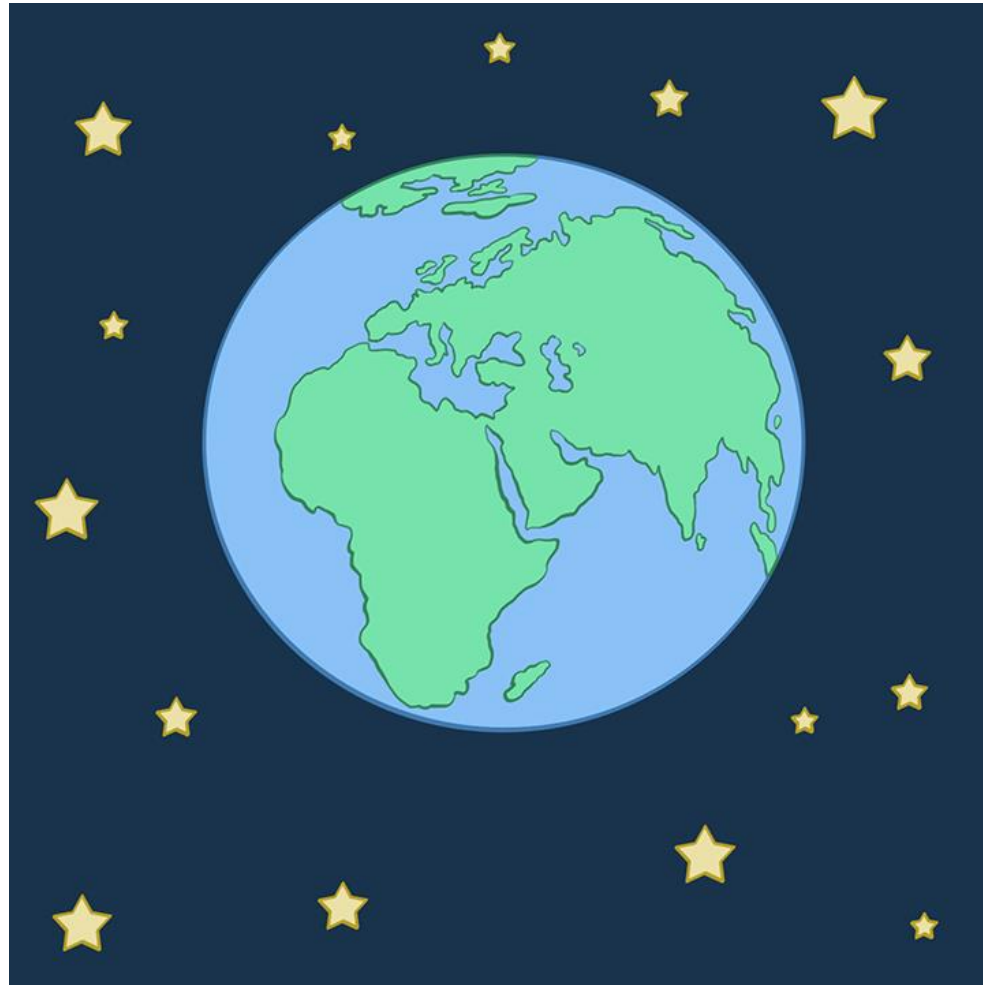



# world

This special soap is good  
for the \_\_\_\_\_.



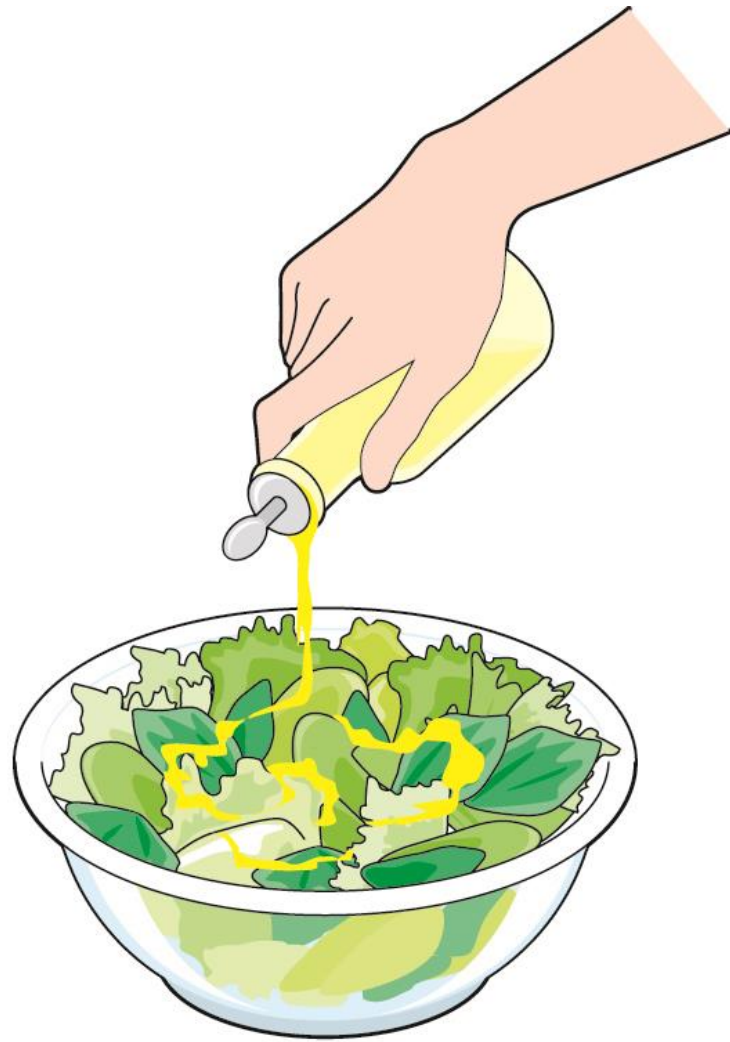



# add

Tim \_\_\_\_\_ other things.





# boil

My mom \_\_\_\_\_ the  
soup.





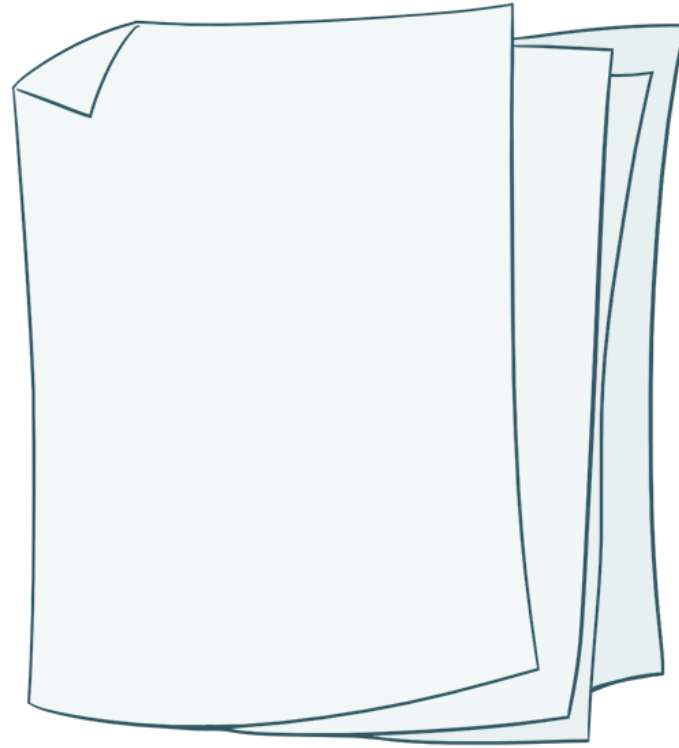



paper

\_\_\_\_\_ planes are fun.



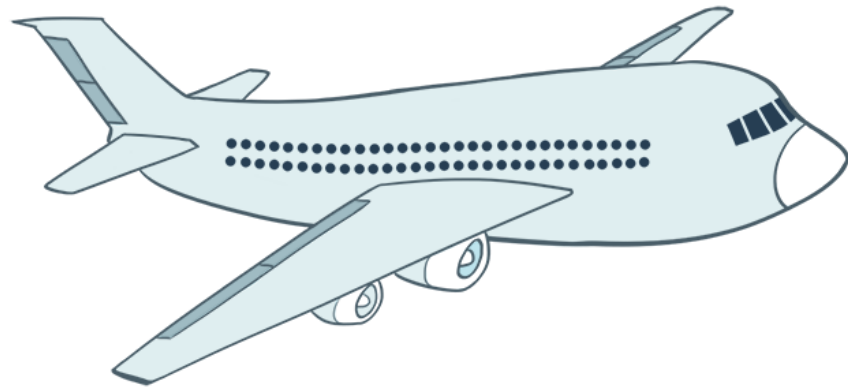



# plane

Paper \_\_\_\_\_ are pretty  
easy to make.

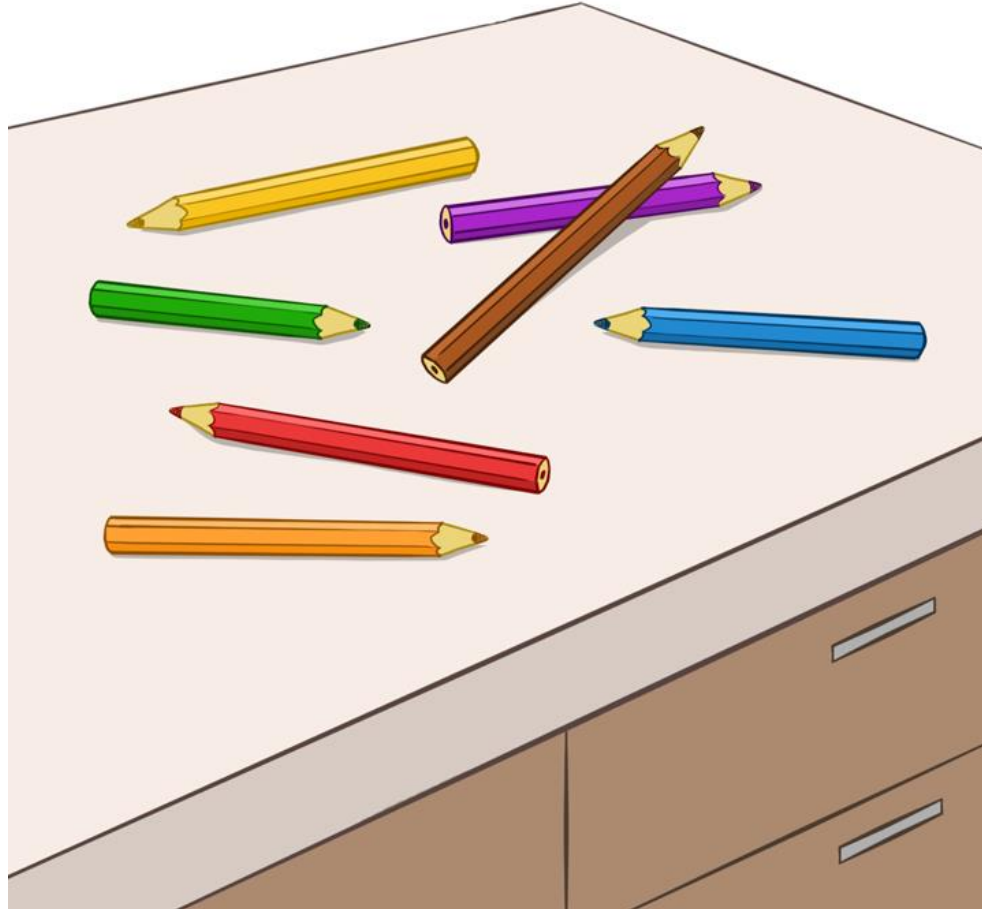



# some

Take \_\_\_\_\_ paper and  
put the parts together.







# look like

Draw on the paper to  
make it \_\_\_\_\_ a plane.



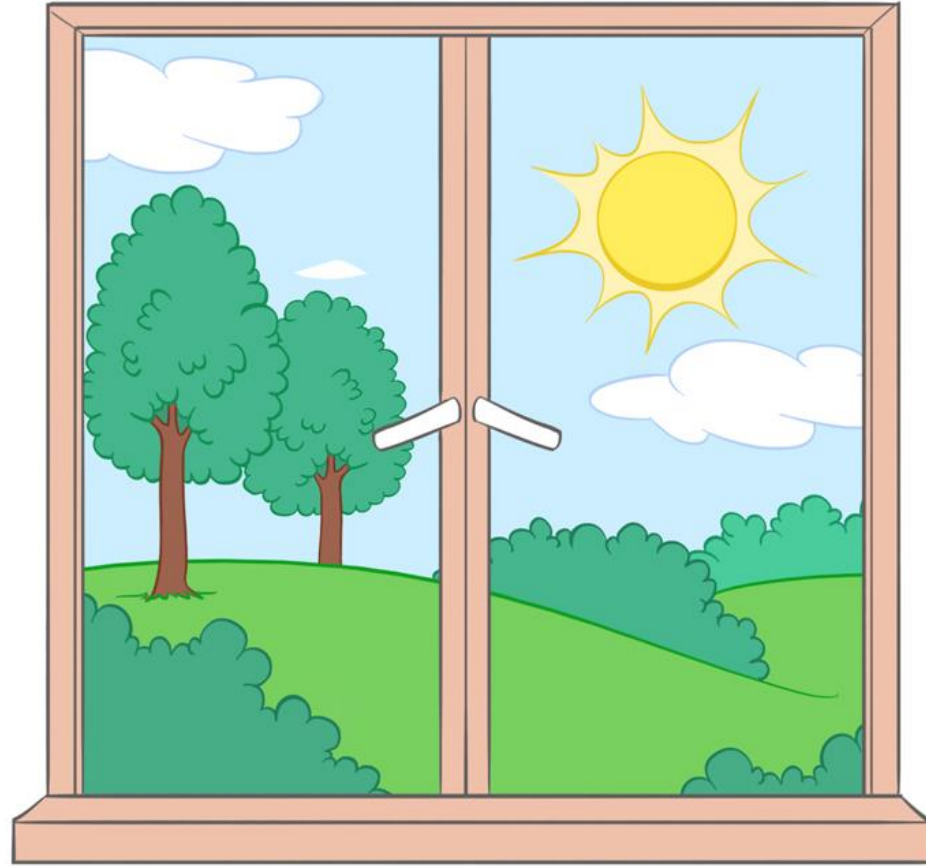



# window

Draw \_\_\_\_\_ and  
people's faces in them.

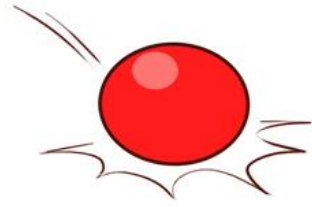



# throw

\_\_\_\_\_ your paper  
plane!







# land

The helicopter is about to

\_\_\_\_\_.







# runway

The plane safely landed  
on the \_\_\_\_\_.