

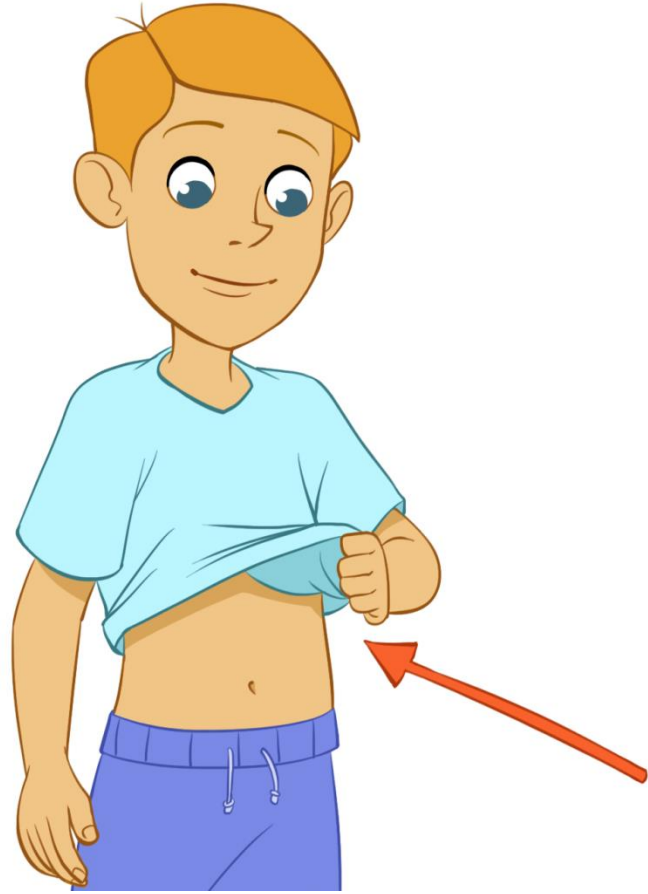



inside

The baby grew _____
Mom's belly.





belly

_____ is another name
for stomach.







eat

Henry needs to _____ .







feed

Mom lets me _____
my brother.



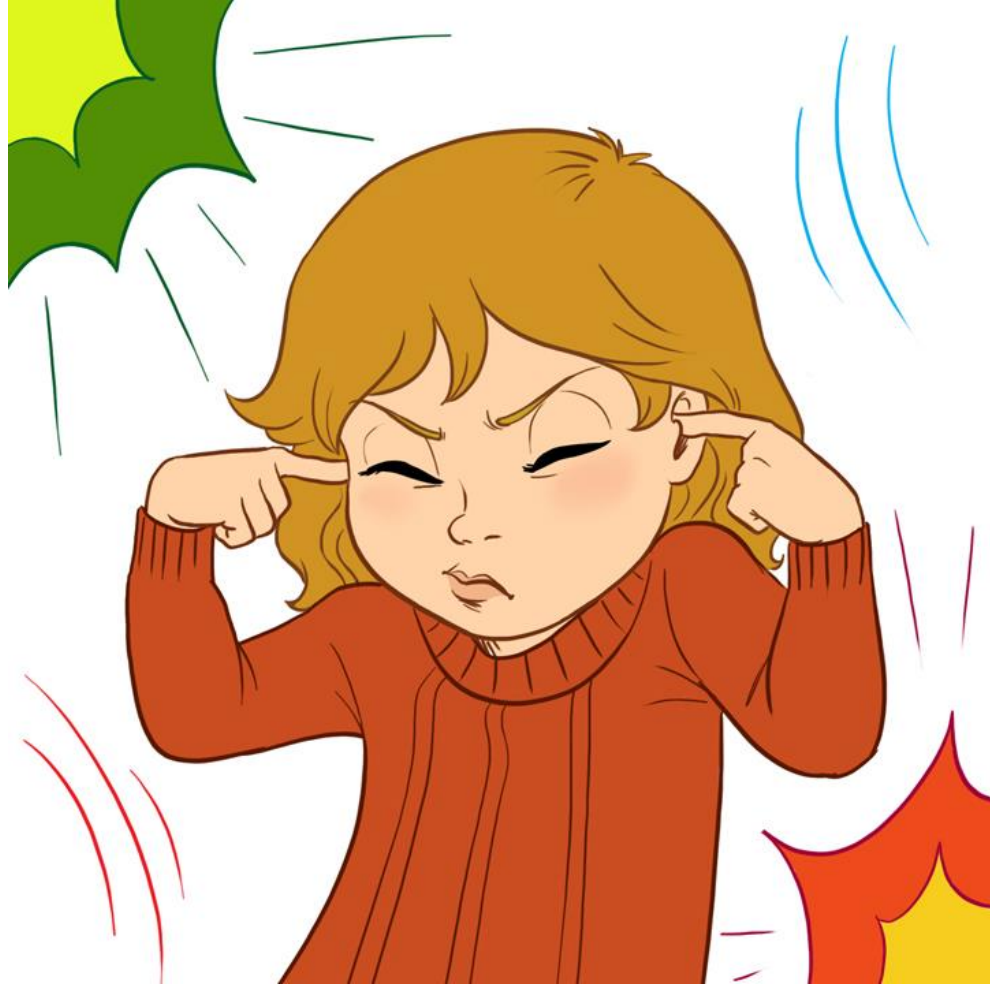



noisy

Henry can be _____,
but I love him.





take care

I love _____ of Henry.







hug

I _____ my mom every
night before bed.





siblings

We are _____.





piece

LEGO didn't invent their
building _____.





wheel

LEGO is the world's
biggest _____ maker.







kilogram

A LEGO piece can hold up
to 432 _____.





break

A LEGO piece doesn't
_____ easily.

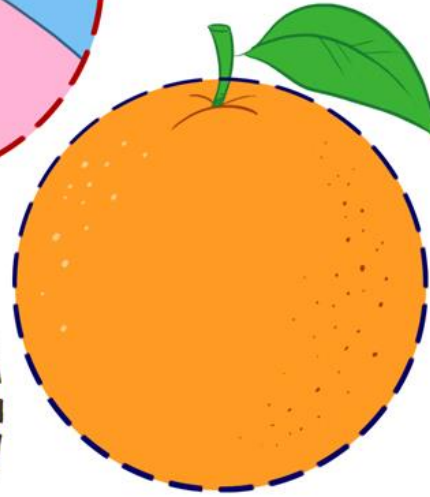
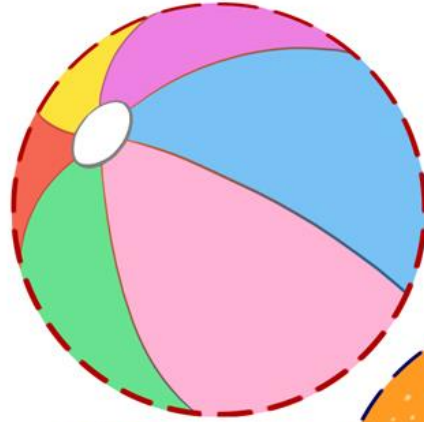



round

LEGO figures have _____
holes in their heads.





hurt

Holes are there so that you
don't _____ yourself.



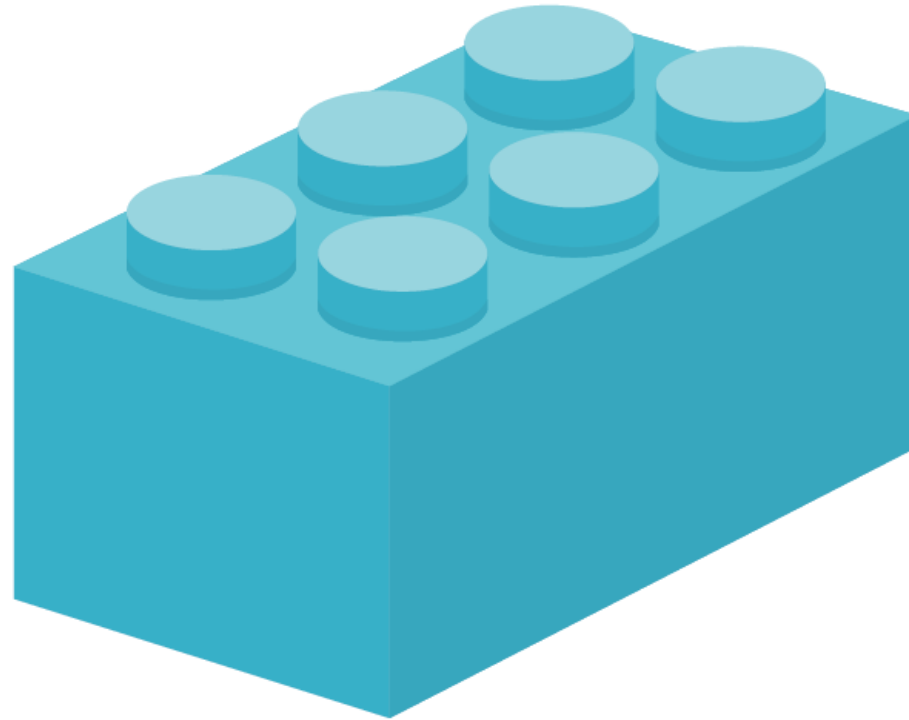



brick

I have many LEGO

_____.

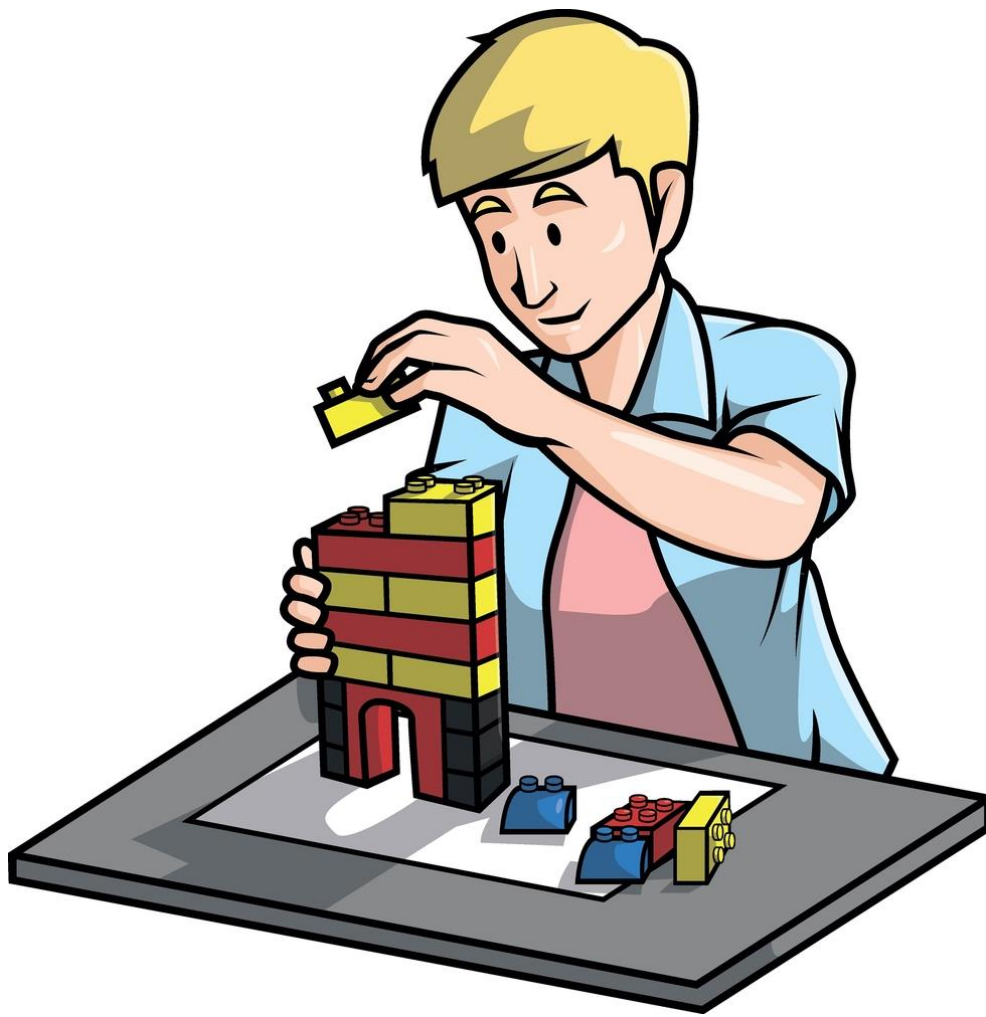



build

You can _____ many things with LEGO pieces.

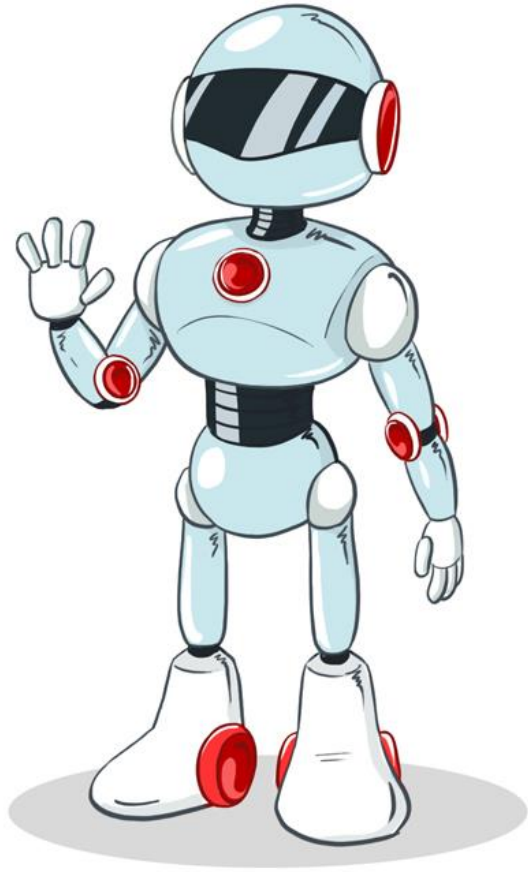



robot

My friend Izzy likes to
make _____.





student

Each _____ makes a
part.

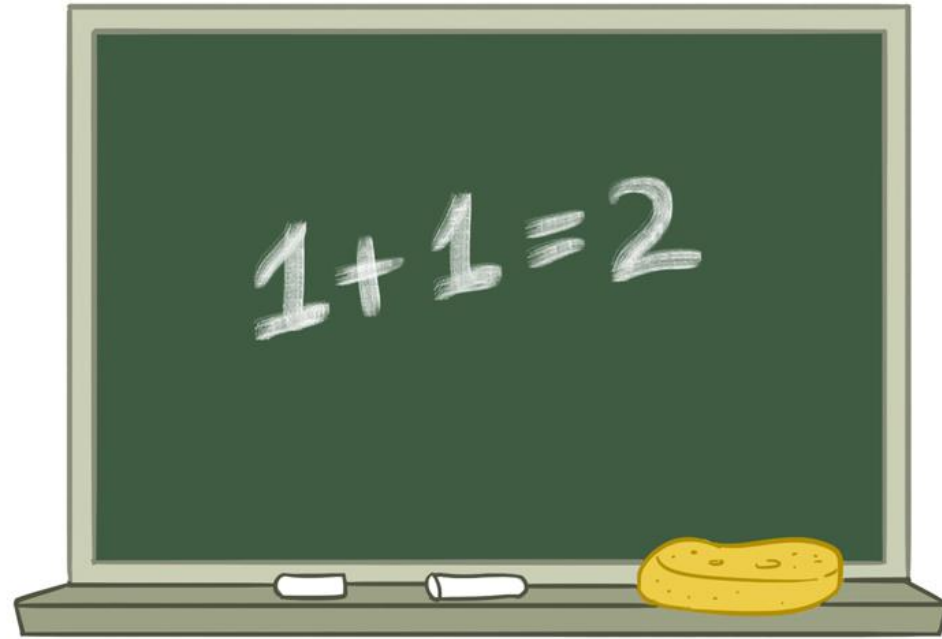



easy

The robots do _____
jobs.



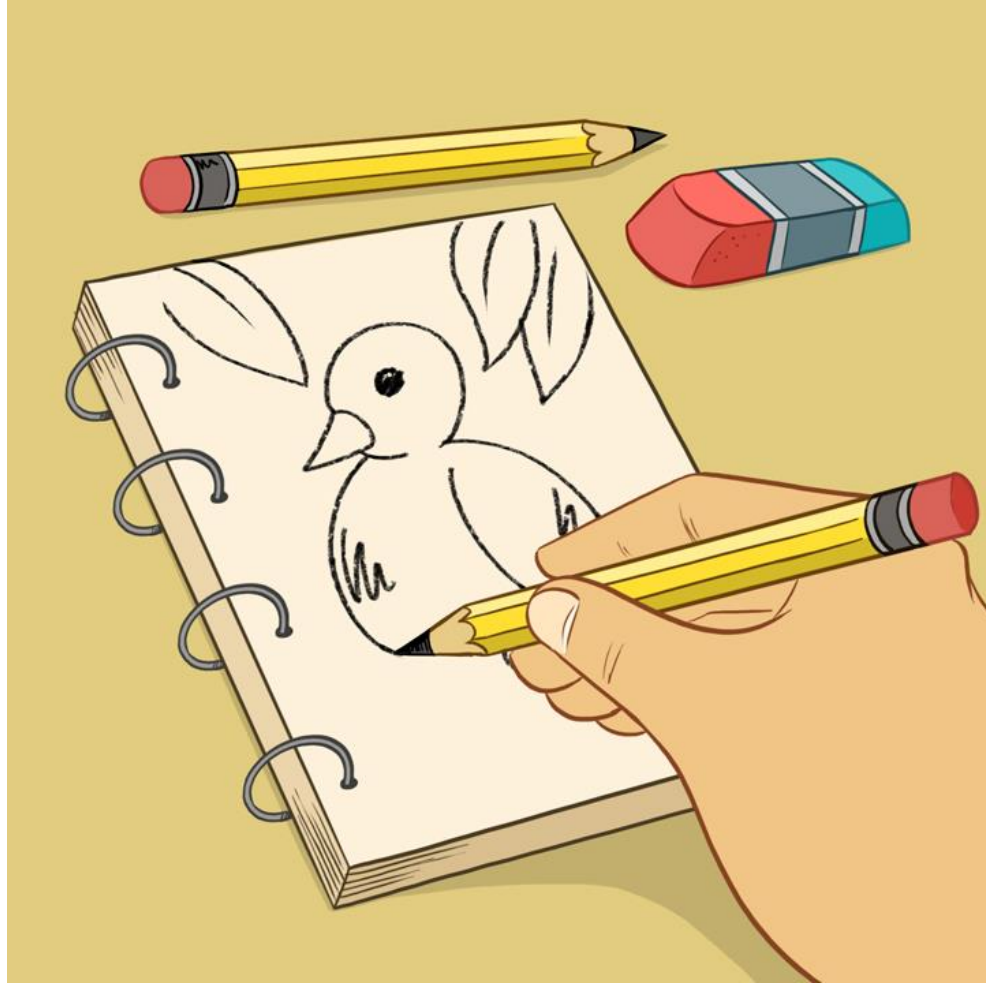



draw

Another robot _____
on paper.





work

It sounds like hard

_____.





cool

Izzy says I will be a
_____ group member.

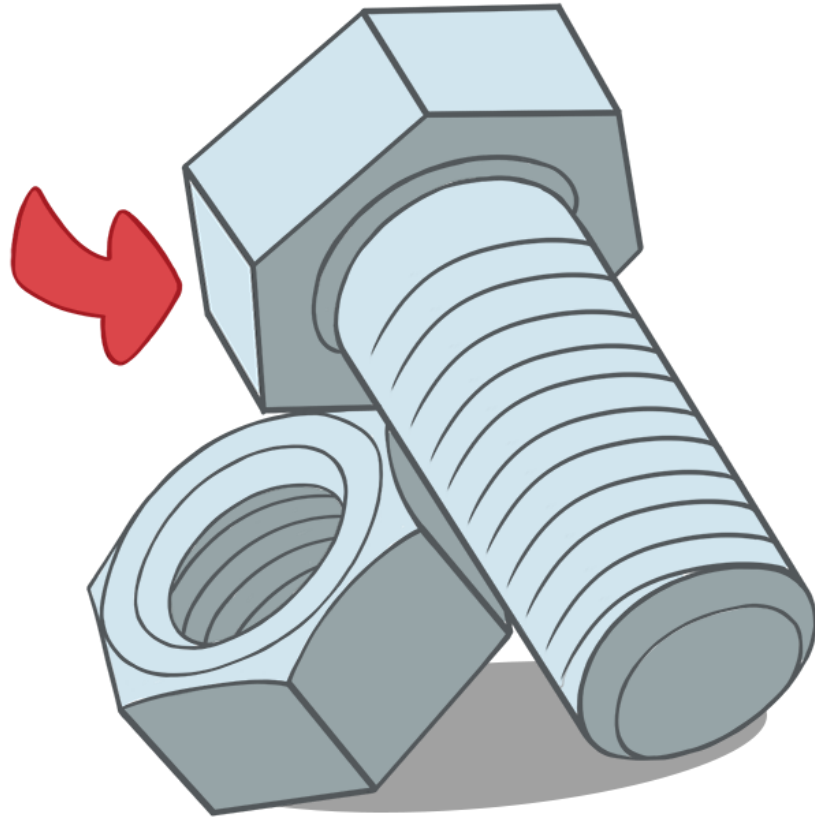



bolt

There were many
_____ in the box.



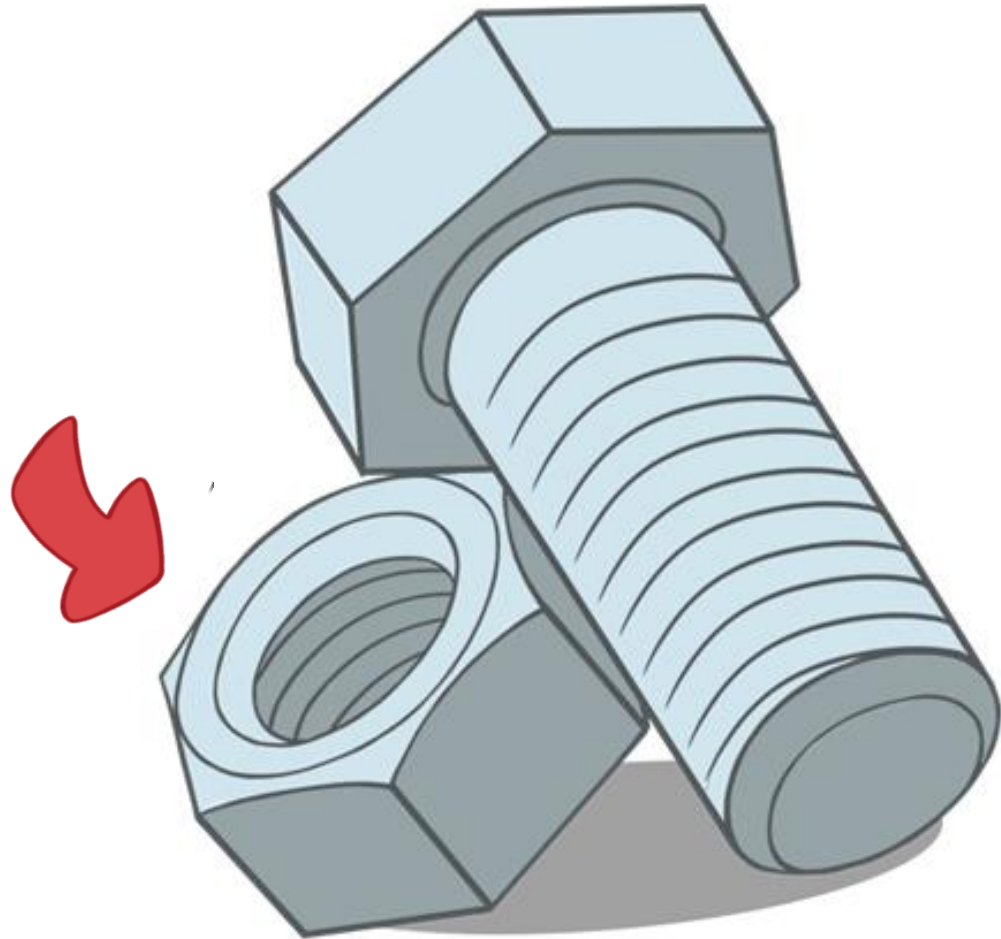



nut

The machine had many

_____.







singer

Come see great _____,
dancers, and actors.







actor

You can see a great
_____ on the stage.





miss

You don't want to
_____ it!



10	11	12	13	14
17	18	19	20	21
24	25	26	27	28
31				

8	9	10	11	12	13	14
15	16	17	18	19	20	21
22	23	24	25	26	27	28
29						

8	9	10	11
15	16	17	18
22	23	24	25
29	30	31	

APRIL

3	4	5	6	7
10	11	12	13	14
17	18	19	20	21
24	25	26	27	28

MAY

1	2	3	4	5	6	7
8	9	10	11	12	13	14
15	16	17	18	19	20	21
22	23	24	25	26	27	28
29	30	31				

JUN

1	2	3	4
8	9	10	11
15	16	17	18
22	23	24	25
29	30		

JULY

3	4	5	6	7
10	11	12	13	14

AUGUST

1	2	3	4	5	6	7
8	9	10	11	12	13	14

SEPTE

1	2	3	4
8	9	10	11





May

My birthday is on
_____ 2nd.







invite

I _____ all of my
friends to the show.





ticket

_____ for kids are \$5.





cast a spell

The wizard _____ on
the frog.





mysterious

I love to read _____
stories.





drop

I am a _____ of water.



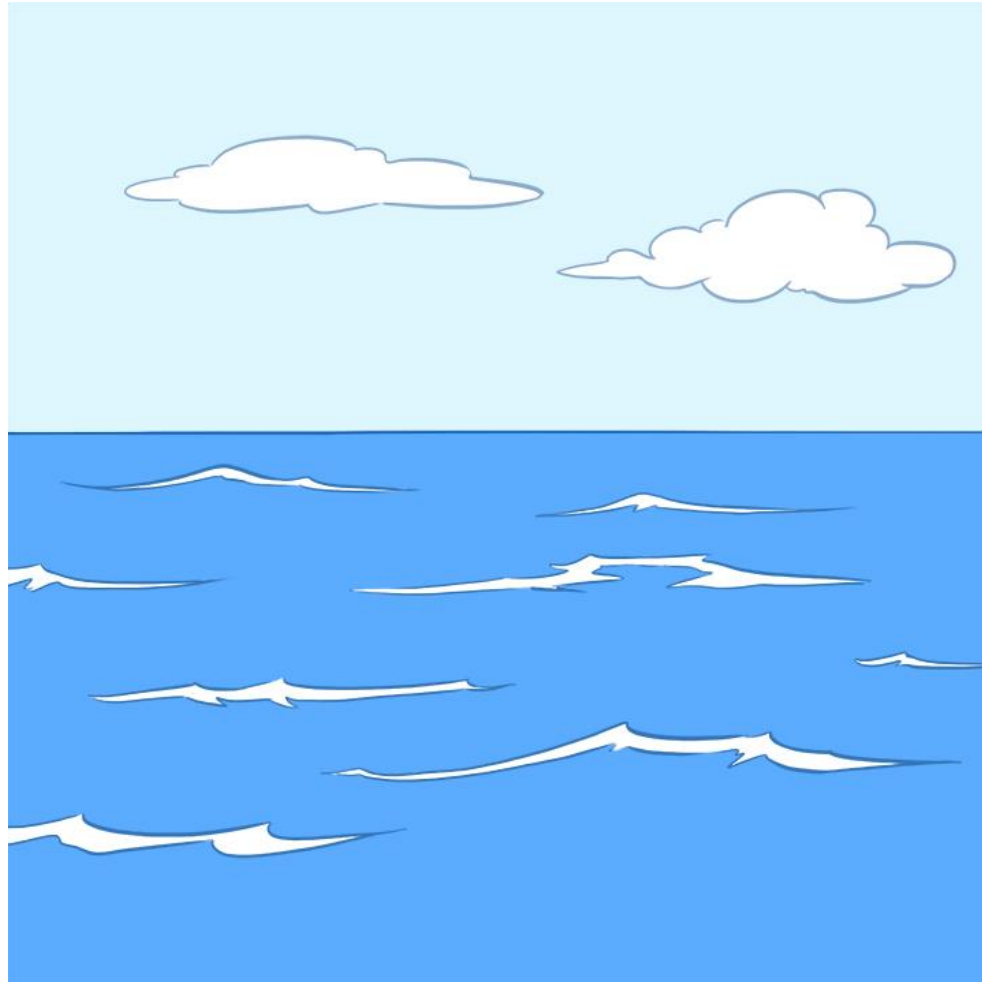



ocean

I like to live in the

_____.







sunny

Then, on a _____ day, I
change!



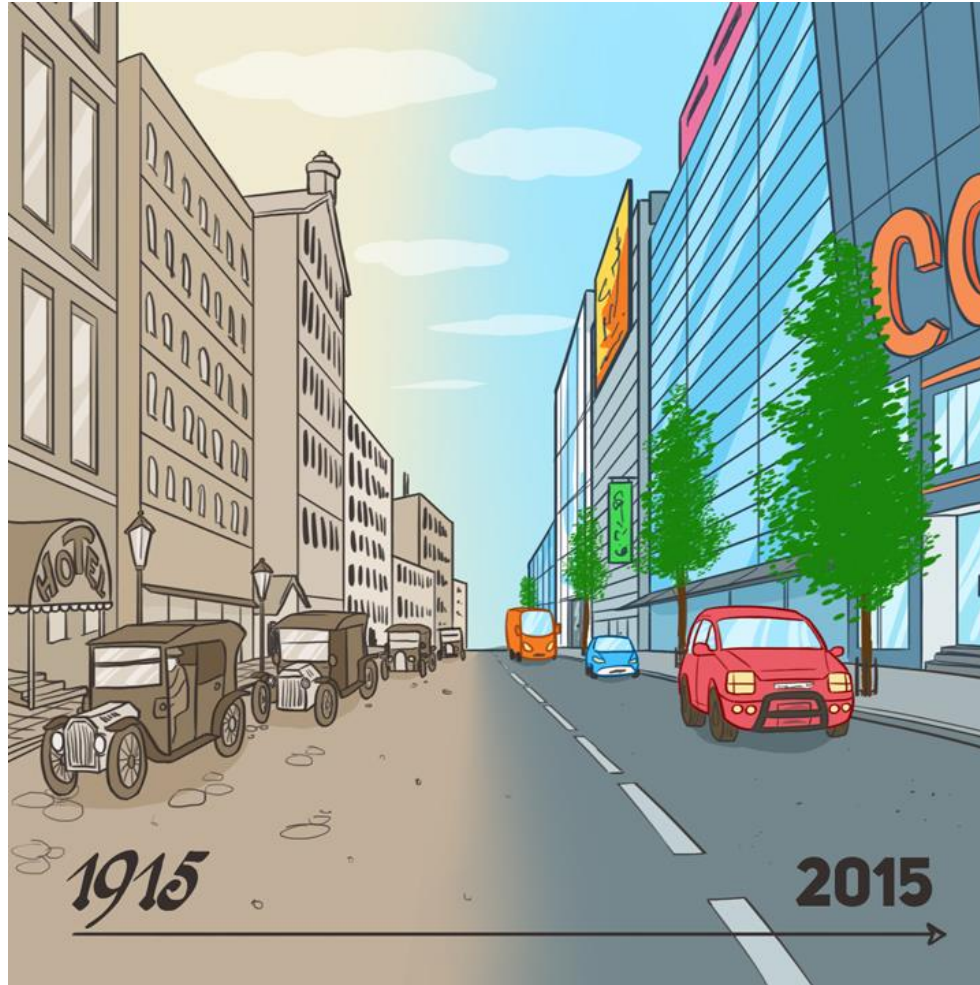



change

Octopuses can _____
color.

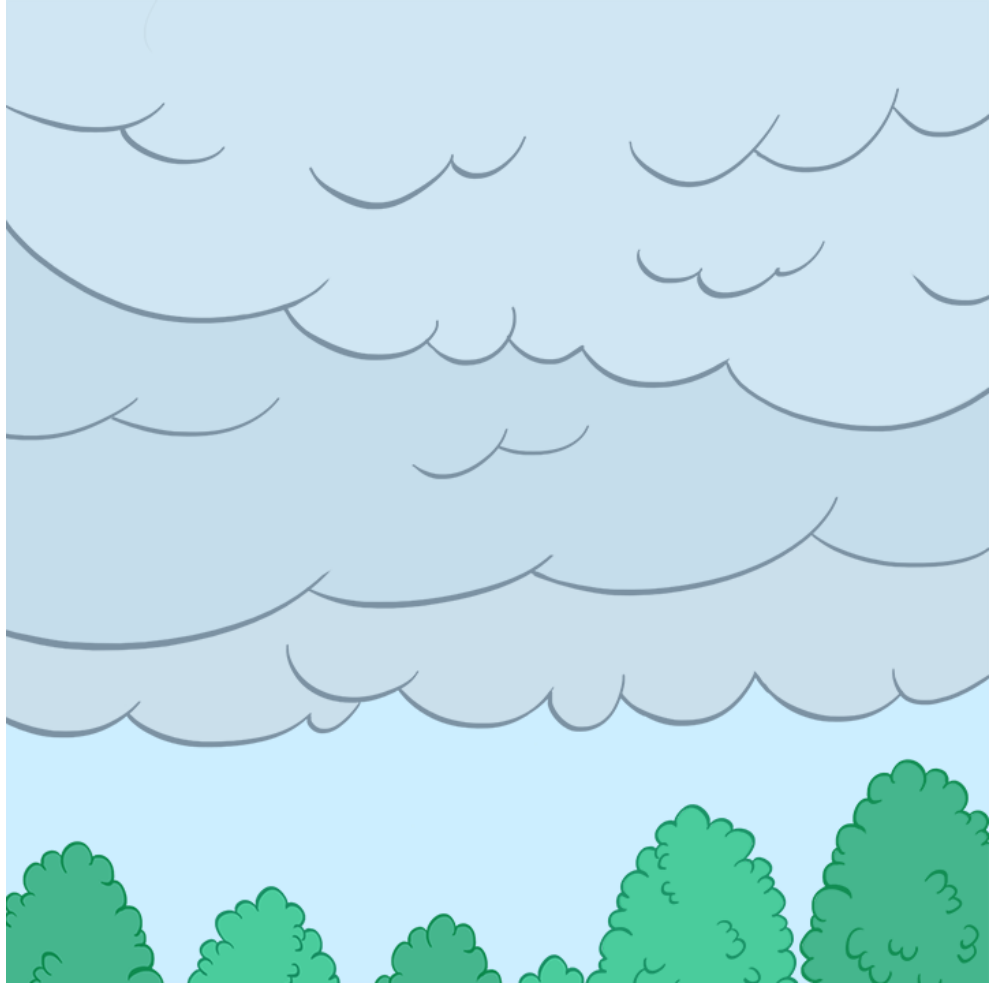



cloudy

We can make the sky

_____.





become

We _____ rain, and we
fall from the sky.





rainy

The plants love this
_____ day.





snowy

I love to play outside on
_____ days.



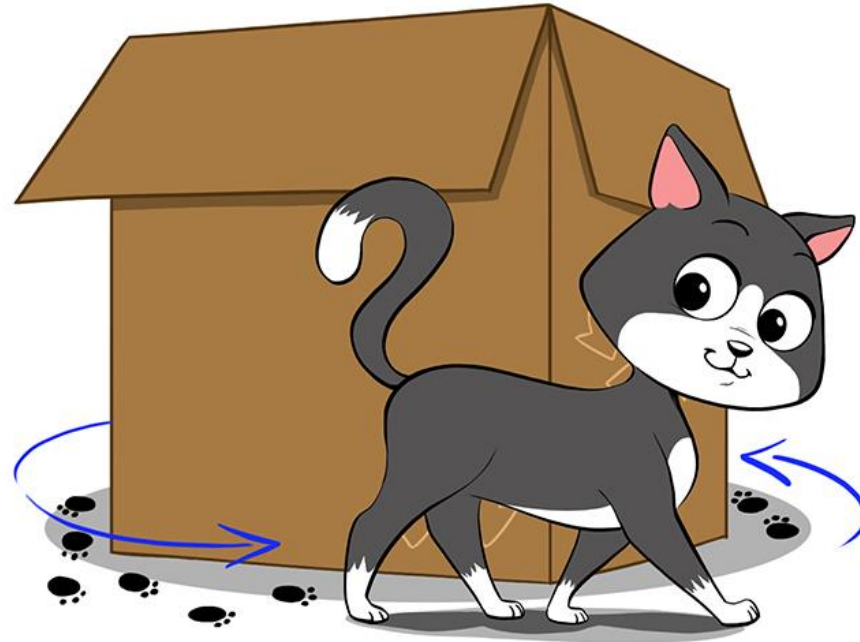



around

The cat walked the
_____ box.

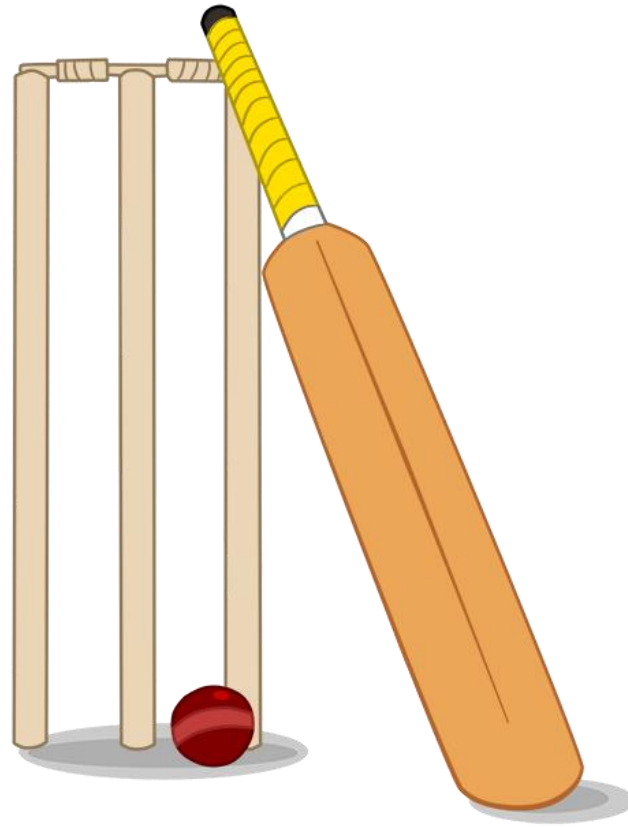



cricket

Some people around the
world love _____.





team

_____ of eleven play
on a field.

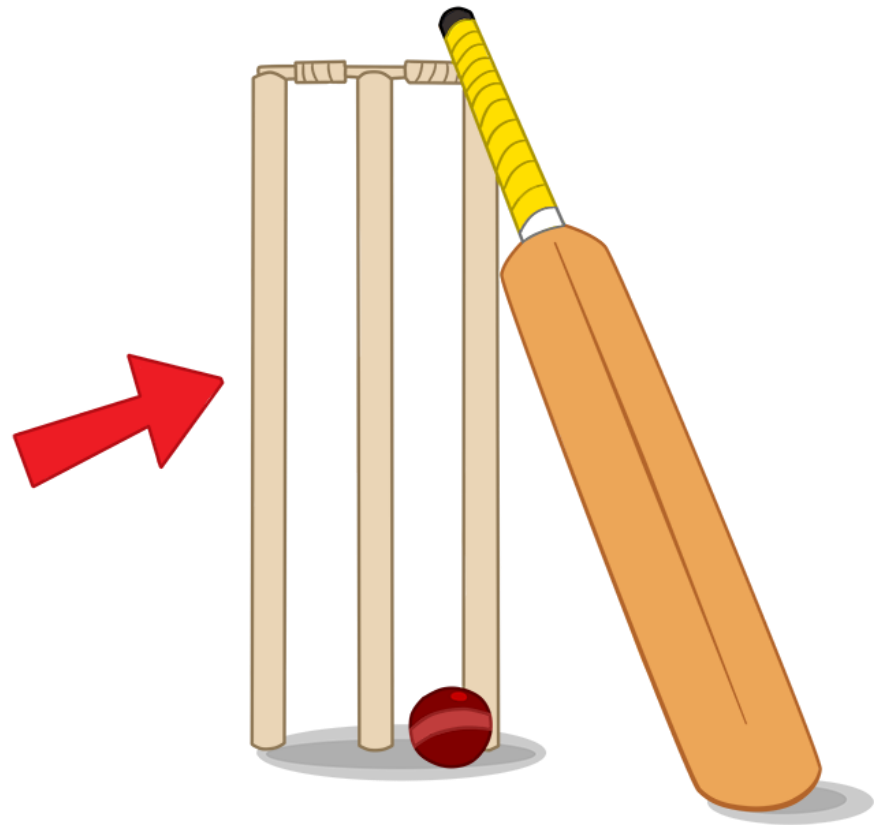



stick

There are _____ on
each end.







hit

If the ball _____ the sticks, Player Two is out.

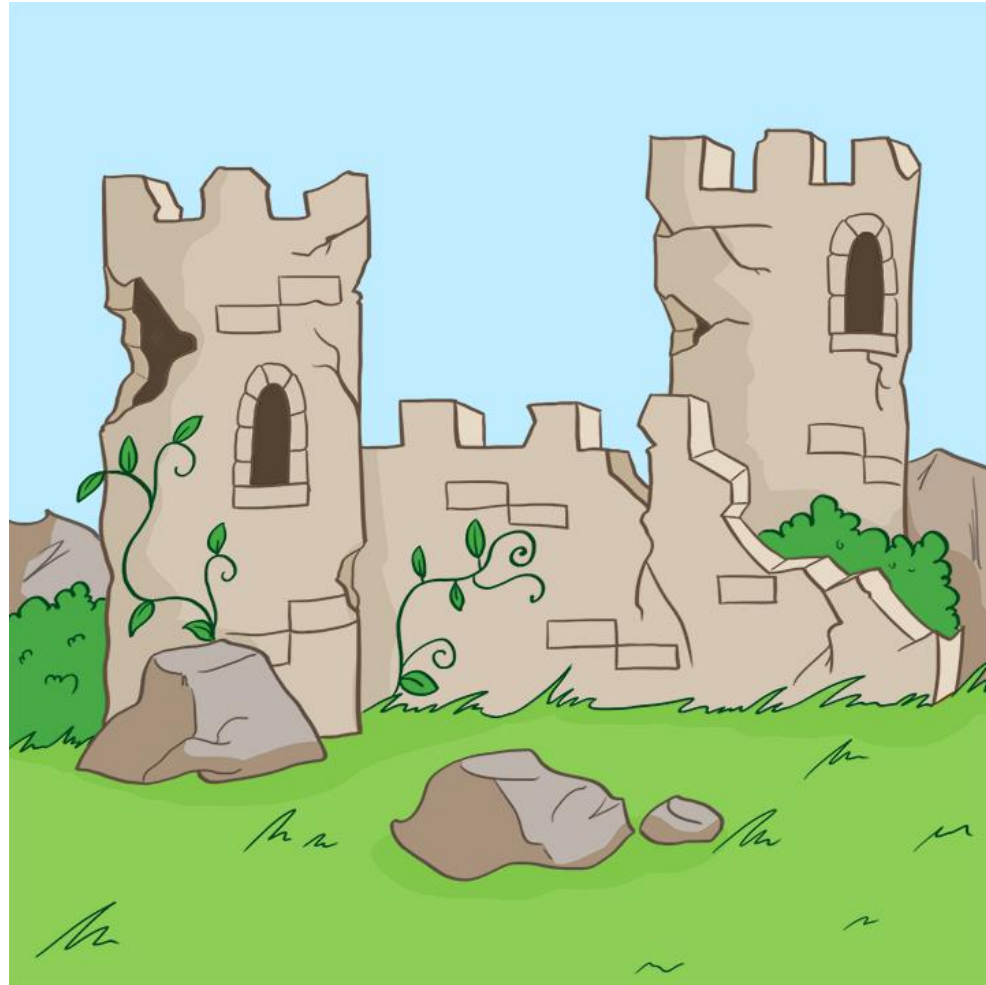



last

A cricket match can
_____ for five days!







bat

A _____ is used to
play cricket.

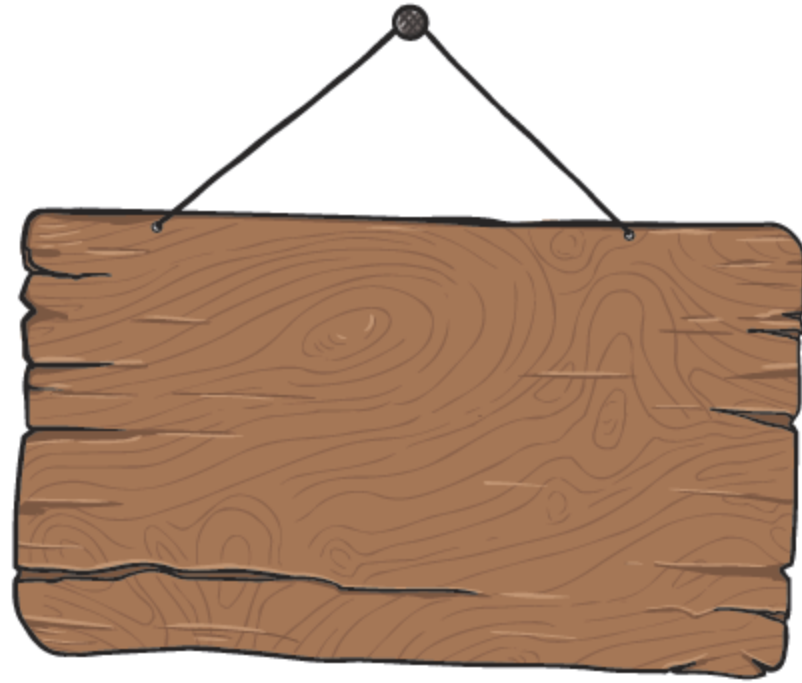



wooden

We play cricket with a
_____ bat.





hurricane

_____ occur near the
ocean.





occur

The wedding is going to
_____ at 6 p.m. tomorrow.

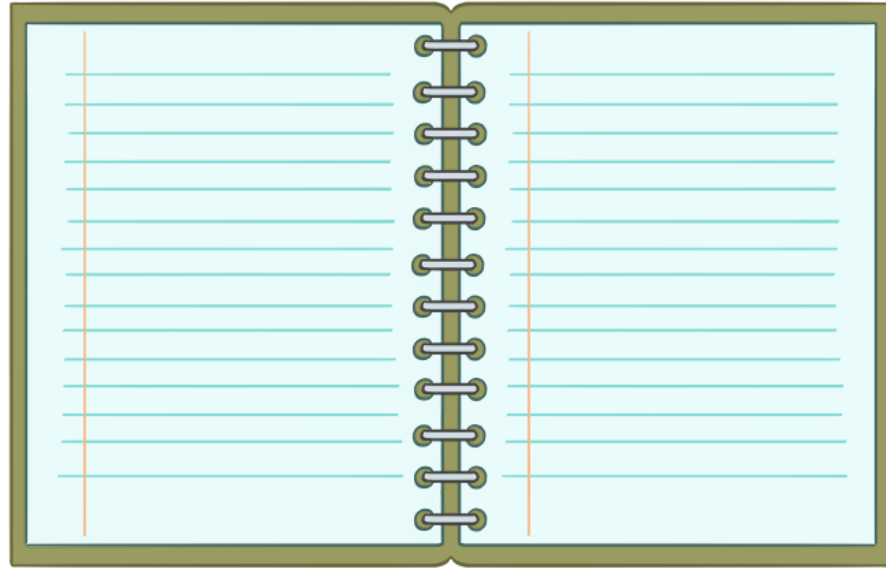



near

The tree _____ my
house is very tall.







badly

After a hurricane, people
_____ need help.





think

Mom _____ we should
help out.

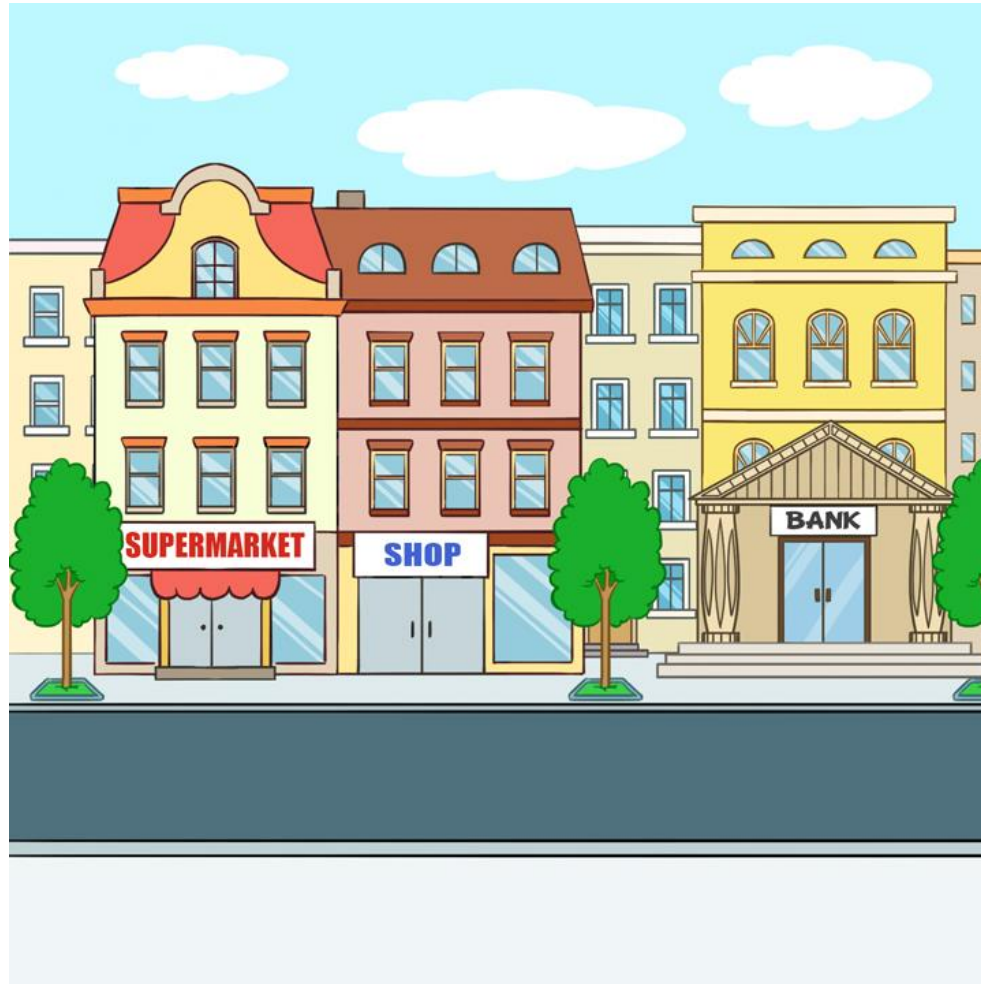



town

We drive to a nearby

_____.





aid

Because of the hurricane,
people need food _____.







volunteer

They always _____ to
help.





present

"I have a _____ for
you," Grandpa said.

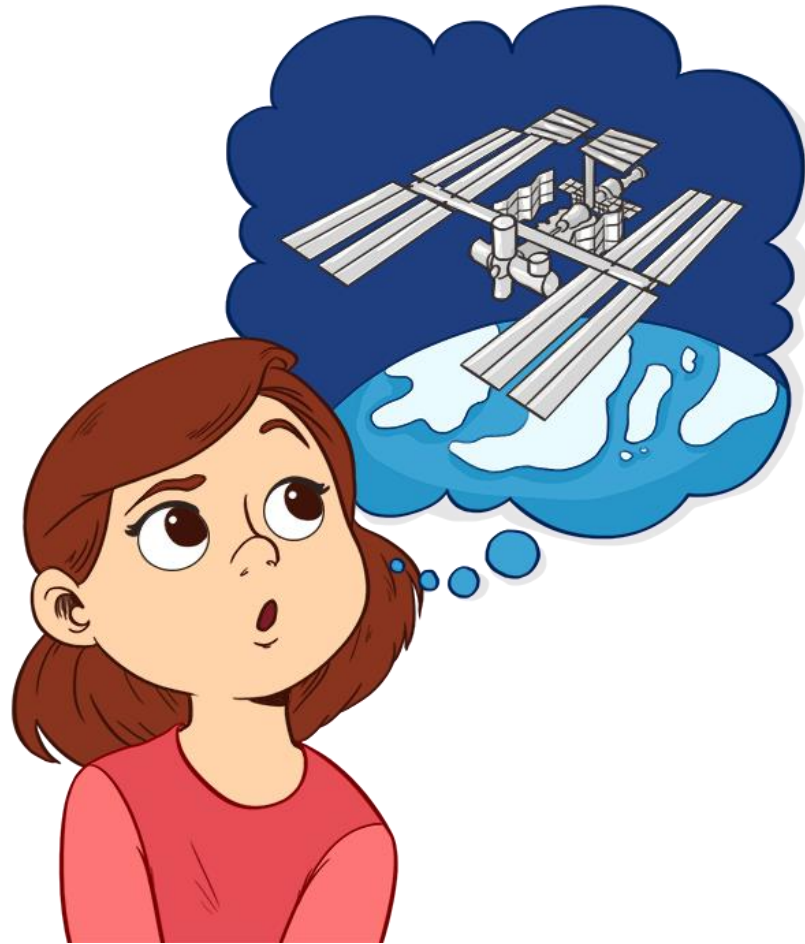



wonder

I _____ what the
present was.





blow

Their coach shouts,
" _____ the whistle!"





instrument

Grandpa blew the long

_____.





ready

I was _____ for my first
concert.





proud

Grandpa was _____ of
me.





play music

We _____ together
every day.





audience

The _____ loved the
concert.





soap

_____ is important.







unhealthy

Many soaps have
_____ things in them.





choose

Some people _____ to
make soap at home.





a few

You just need a bottle of oil
and _____ other things.





natural

This kind of soap is

_____.

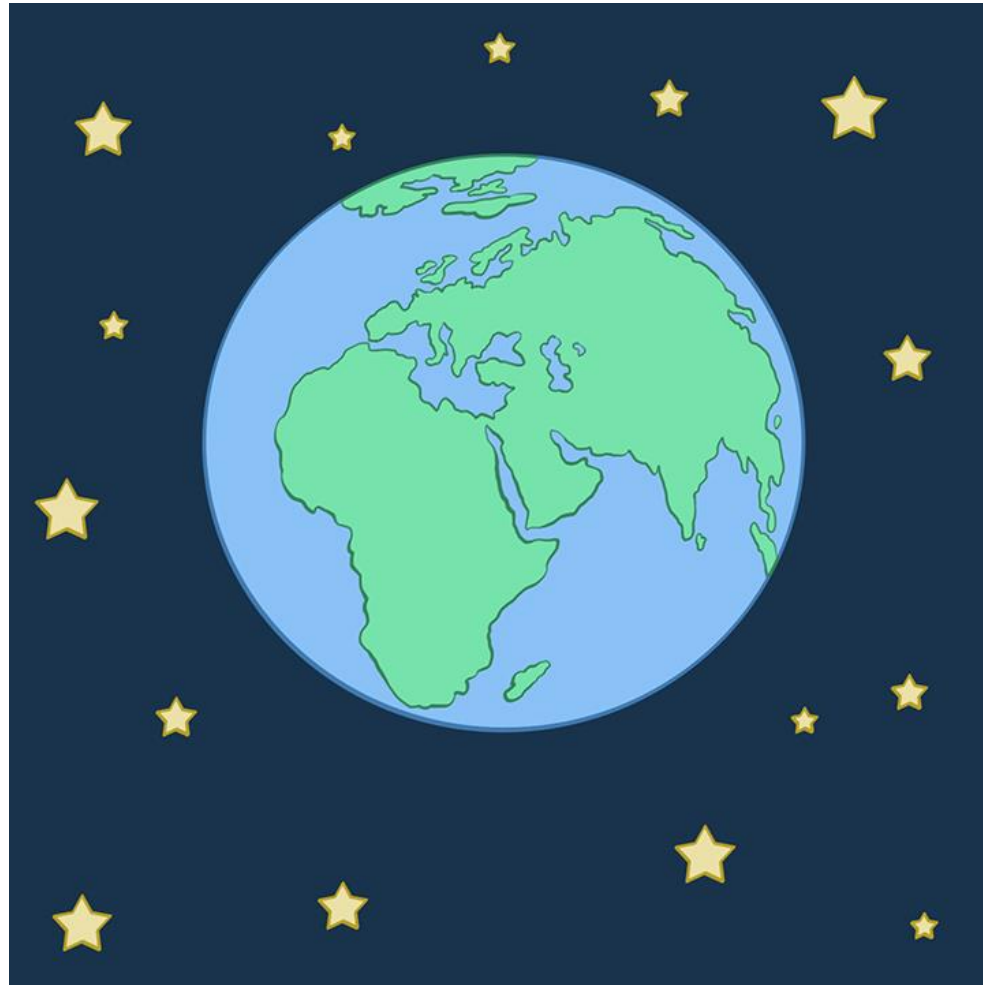



world

This special soap is good
for the _____.



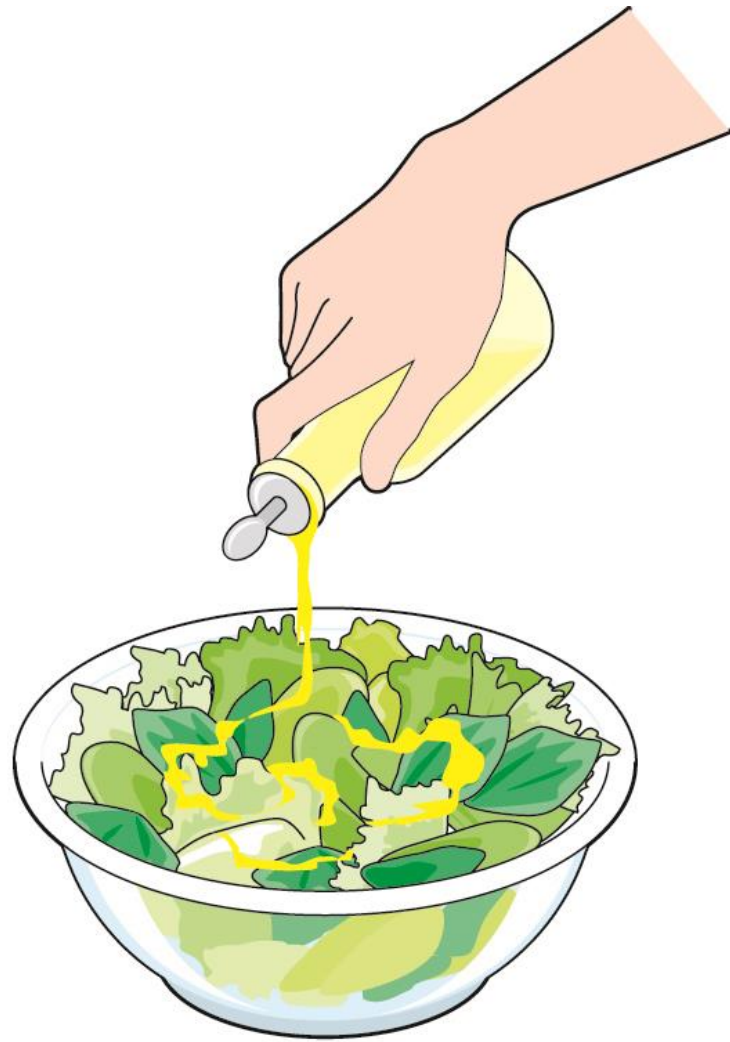



add

Tim _____ other things.





boil

My mom _____ the
soup.







shout

"There's a fire!" he

_____.





firefighter

When the _____
arrived, Cara went to Steve.





cry

“Patches is inside somewhere,”
Steve _____.







rush

Cara _____ inside and
carried Patches to the window.





photographer

A _____ took their
pictures.





job

“That’s our _____,”
said Walter and Cara.





dangerous

It's _____ to walk on
an old bridge.





rescue

The firefighters _____ the child from the burning building.





hobby

My brother and I have a

_____.





camp

We like to _____.



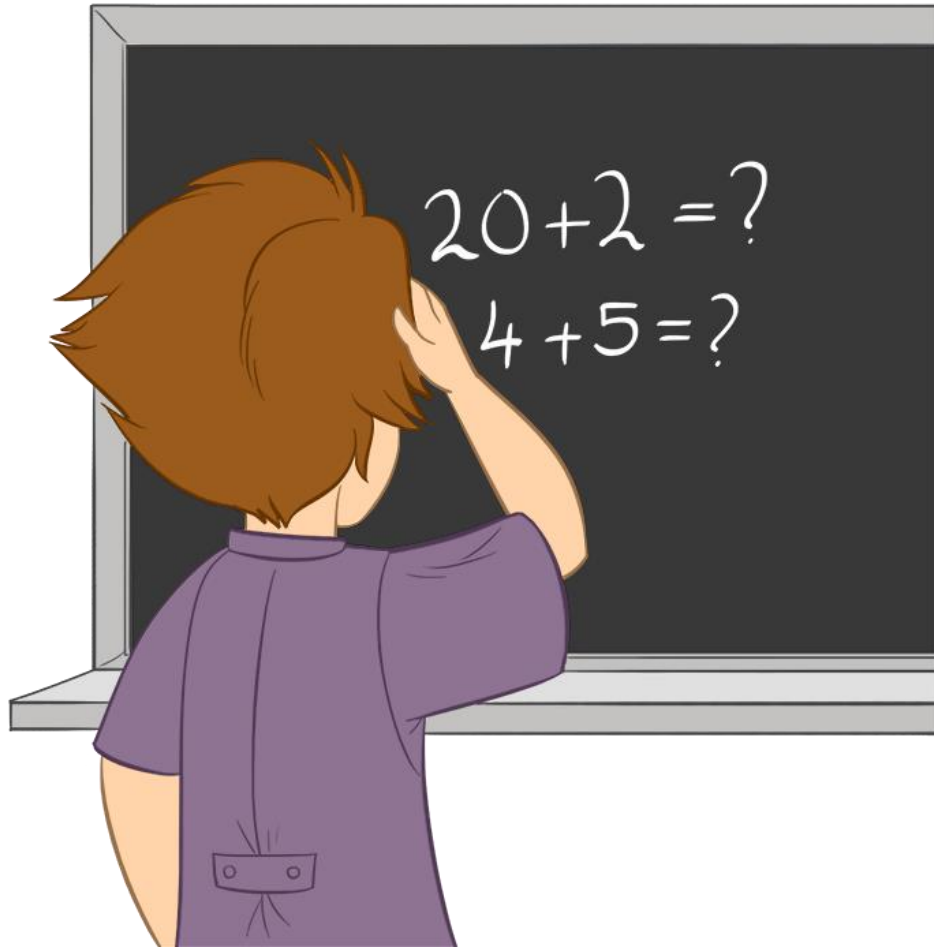



problem

“We have a _____!”
I shouted.





lose

I _____ the map.







mad

My brother was not
_____ at me.







smartphone

My brother had his

_____.





indoor

I go swimming in _____
pools in the winter.





outdoor

We wanted an _____
party, but it's raining today.





plate

Yuki's mom put _____
on the table.







begin

Yuki _____ eating with
long, thin sticks.

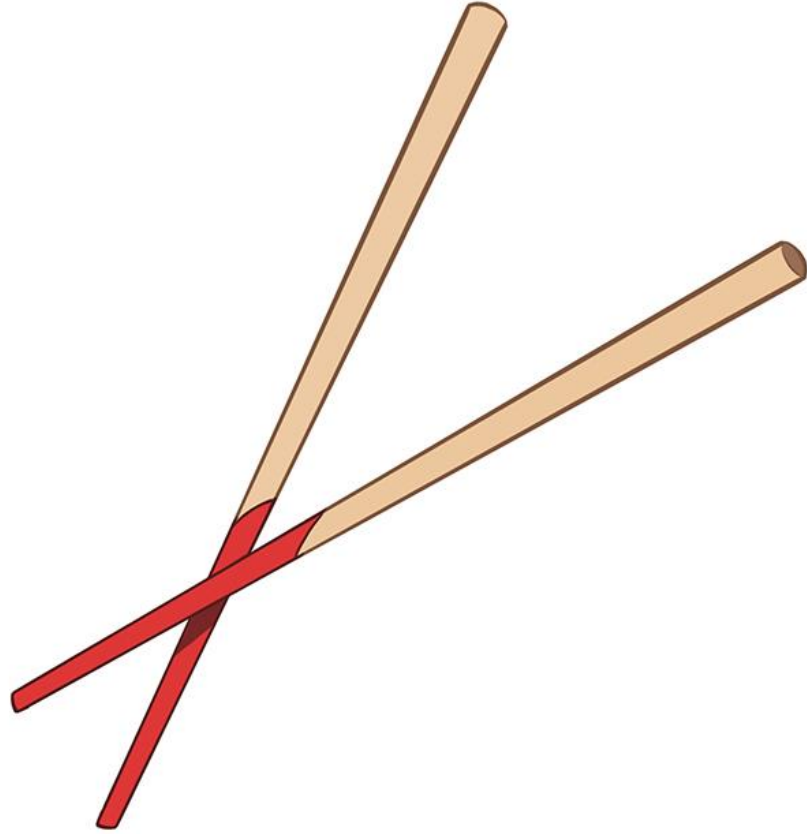



chopsticks

_____ are thin sticks.





sadly

"I can't use chopsticks,"
Pari said _____.





fork

"Do you use _____ in your country?" Gio asked Pari.







rice

Pari made a ball of
_____ with her hand.







chew

The boy happily _____
the pasta.

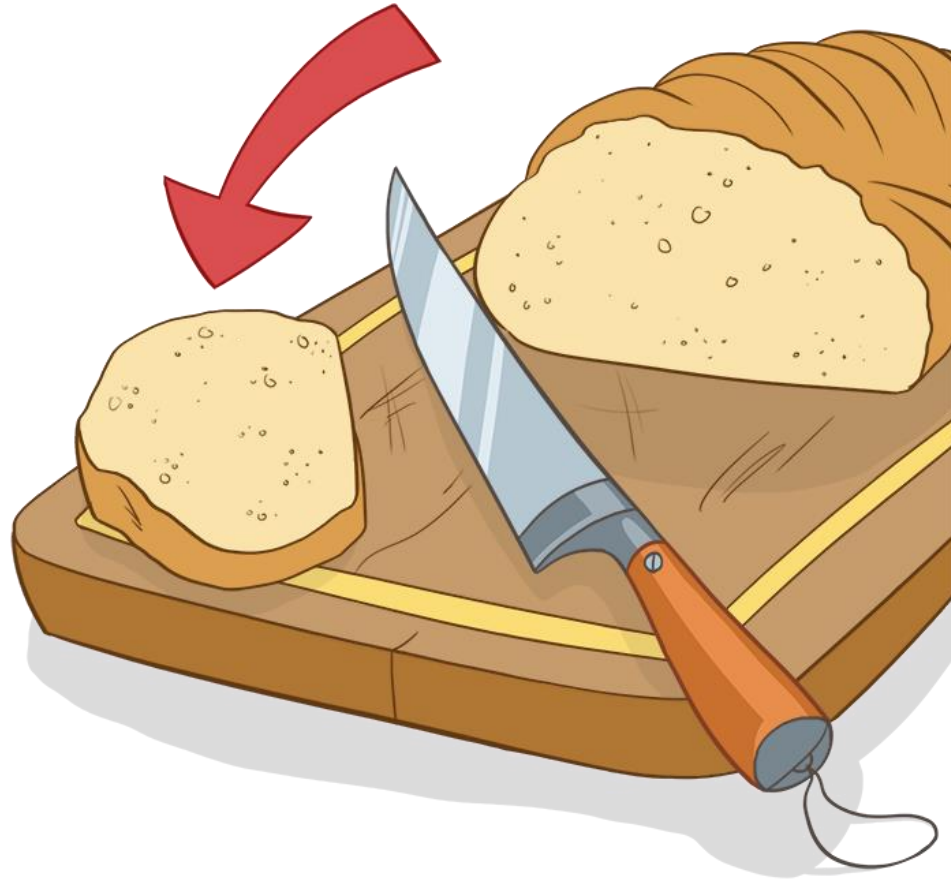



slice

Use this knife to _____
the bread.



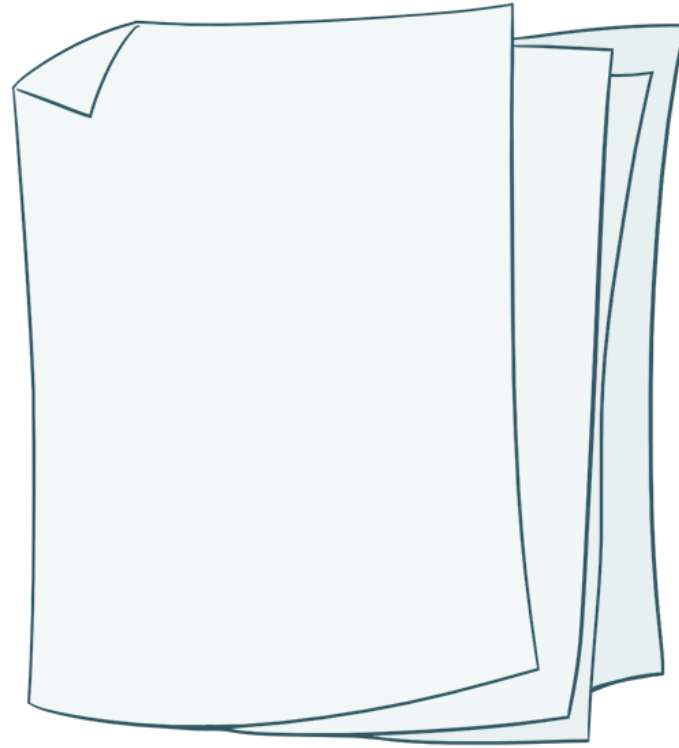



paper

_____ planes are fun.



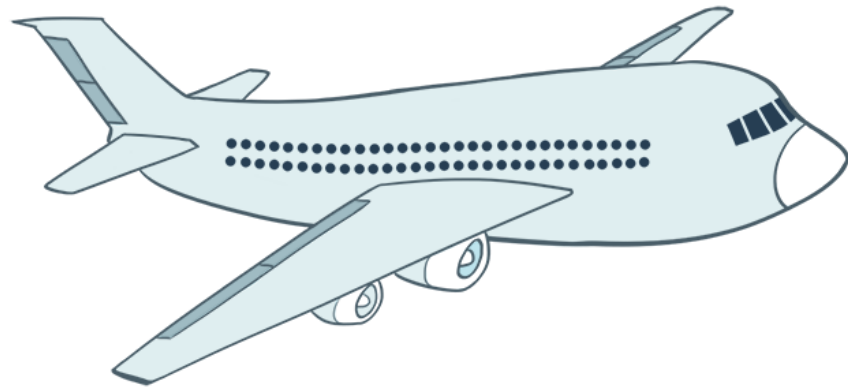



plane

Paper _____ are pretty
easy to make.

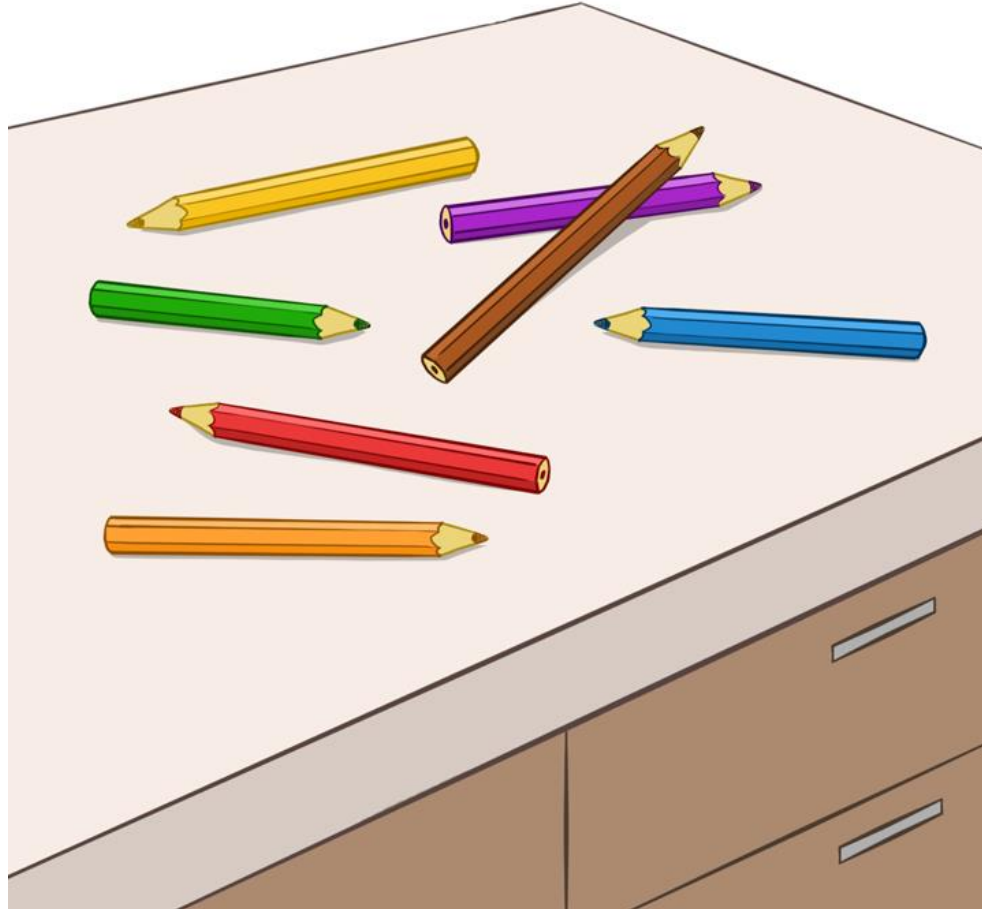



some

Take _____ paper and
put the parts together.







look like

Draw on the paper to
make it _____ a plane.

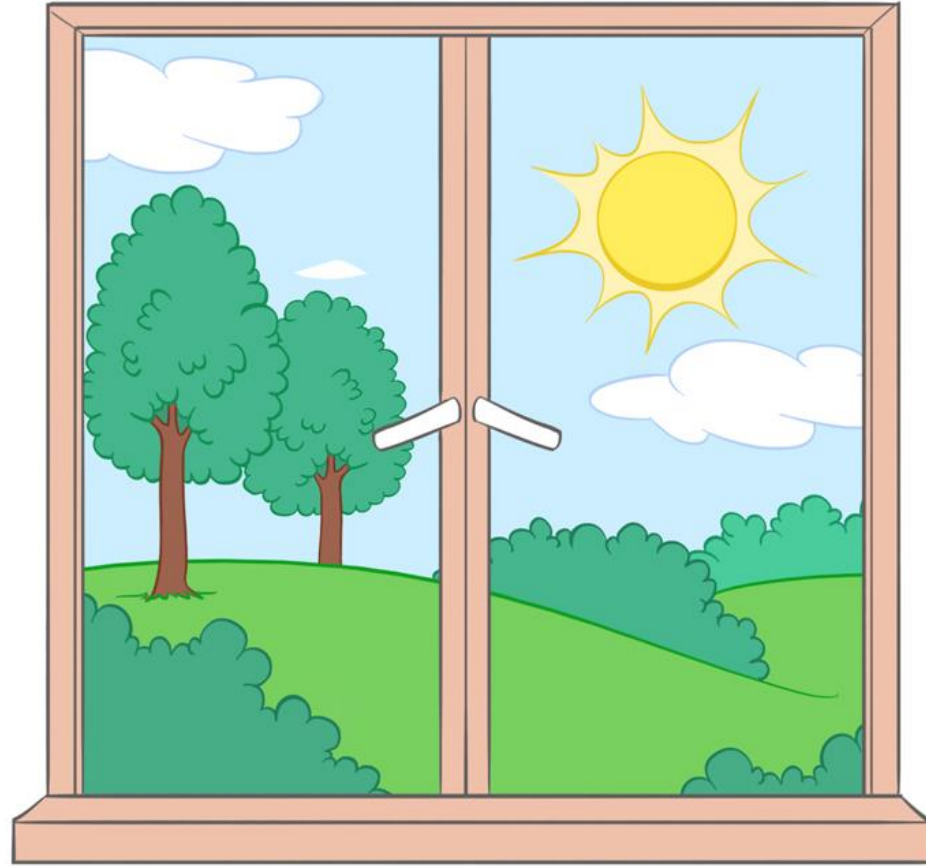



window

Draw _____ and
people's faces in them.

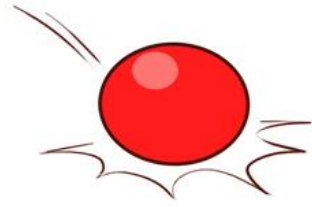



throw

_____ your paper
plane!







land

The helicopter is about to

_____.







runway

The plane safely landed
on the _____.

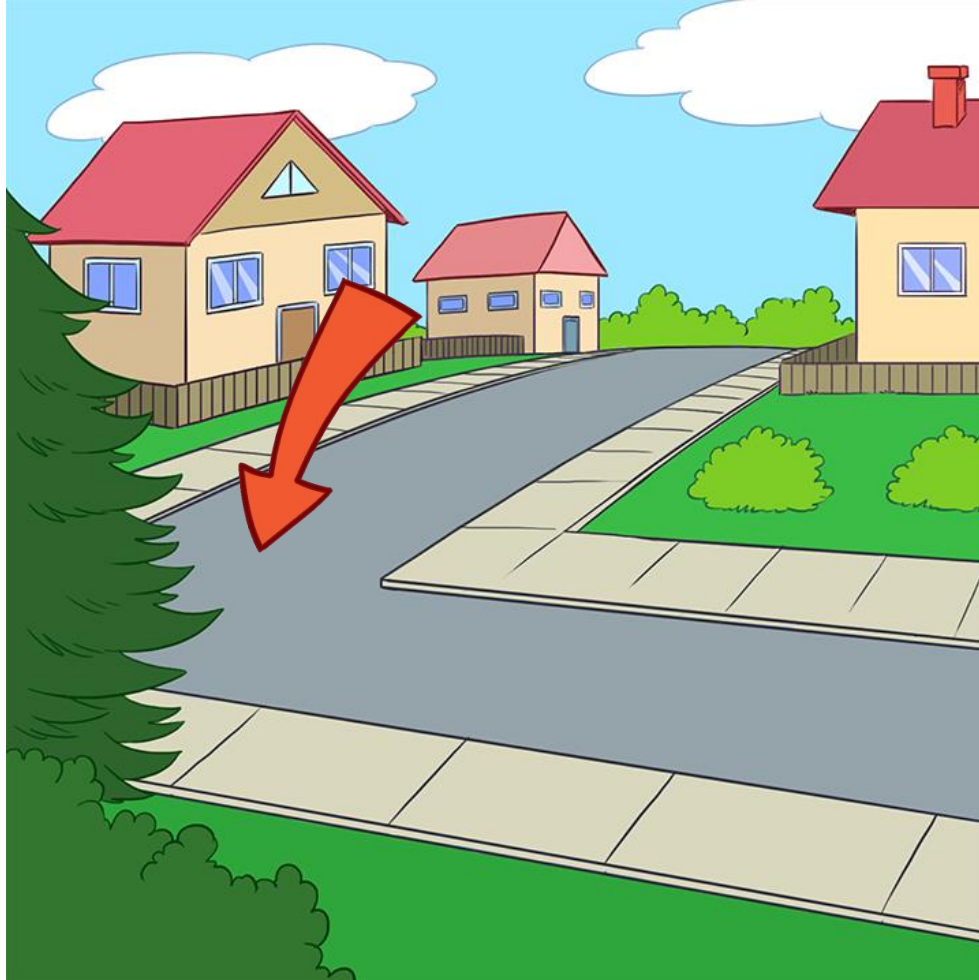



corner

Dad and Billy walk to the

_____.



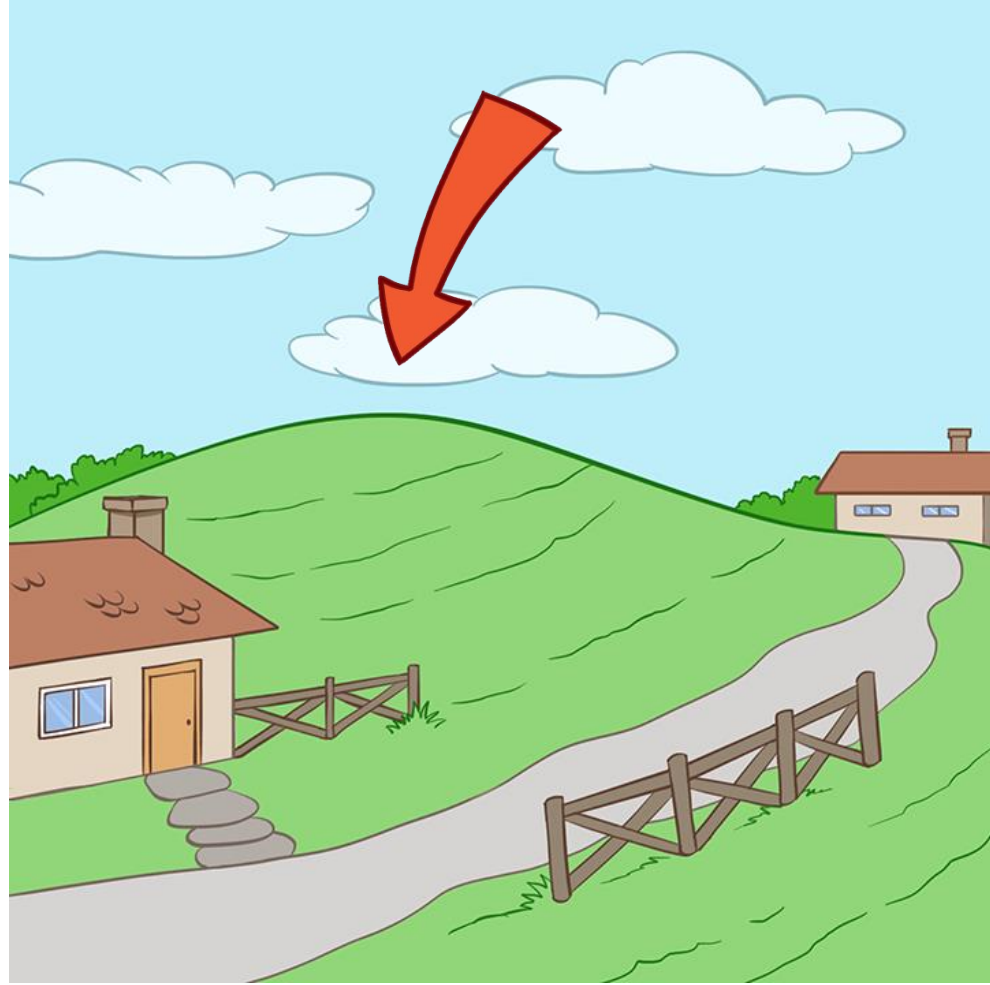



hill

The ball is by the

_____.







terrible

He hears a _____
sound.

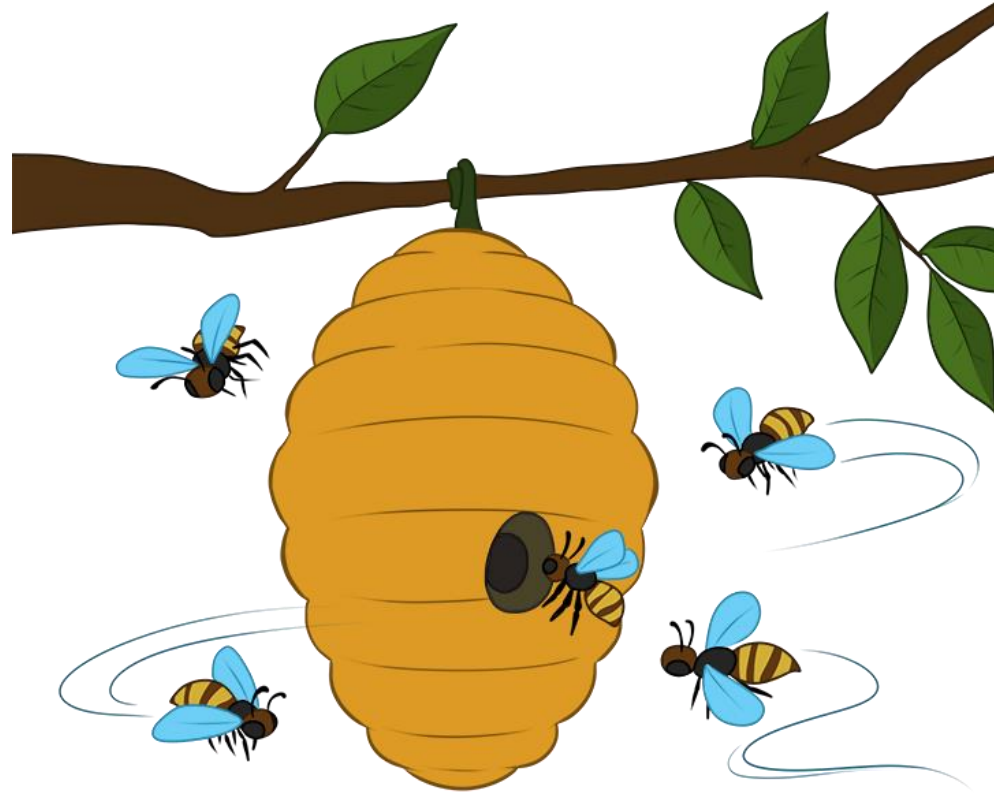



beehive

The holes in the _____
are hexagons.

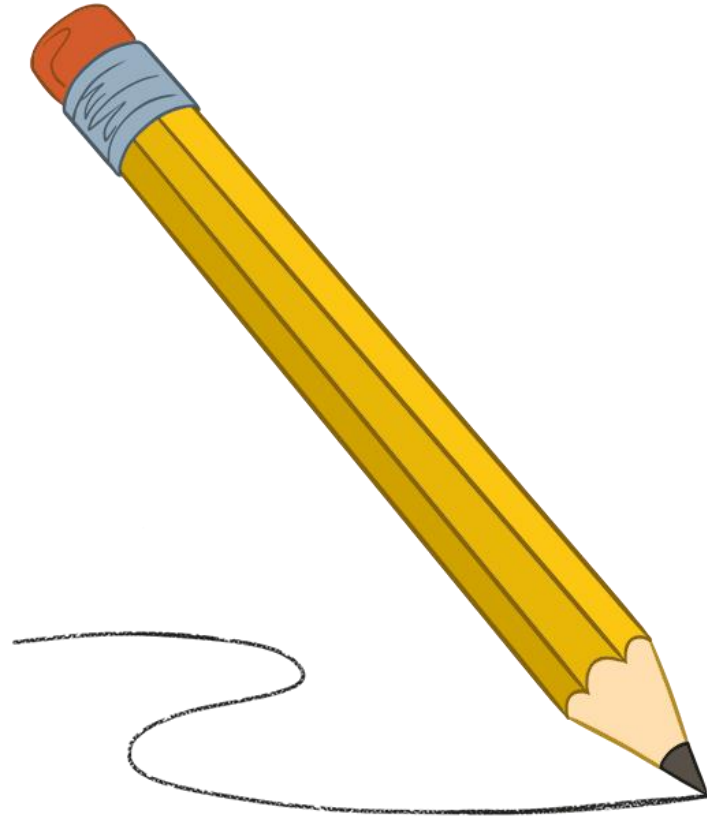



pencil

My _____ is a hexagon,
too!







everywhere

Hexagons are _____!

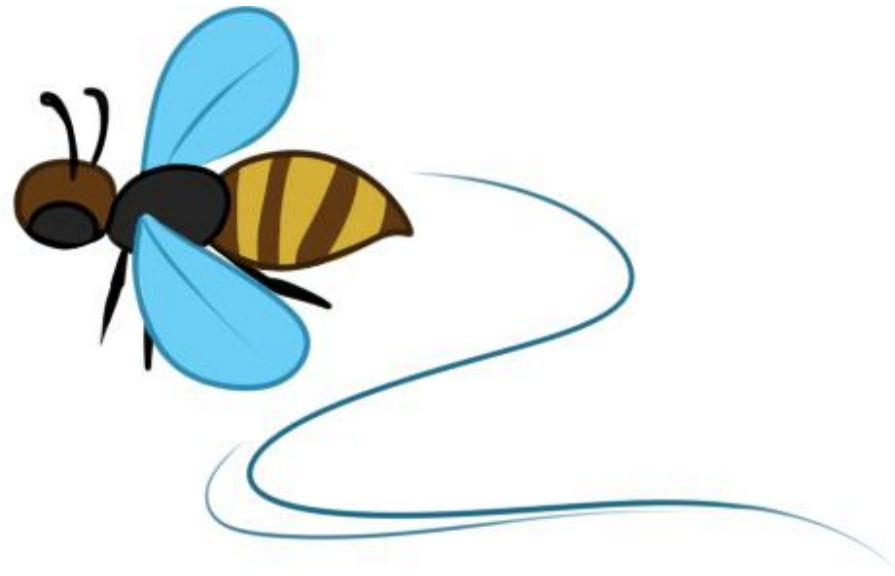



buzz

The bees _____ next to
the flowers.







honeycomb

This golden _____ is a
sweet treat for kids.





evening

In the _____, you can
see stars.





dark

One evening, Jim looks up
at the _____ sky.







see

Jim _____ the sky full
of stars.



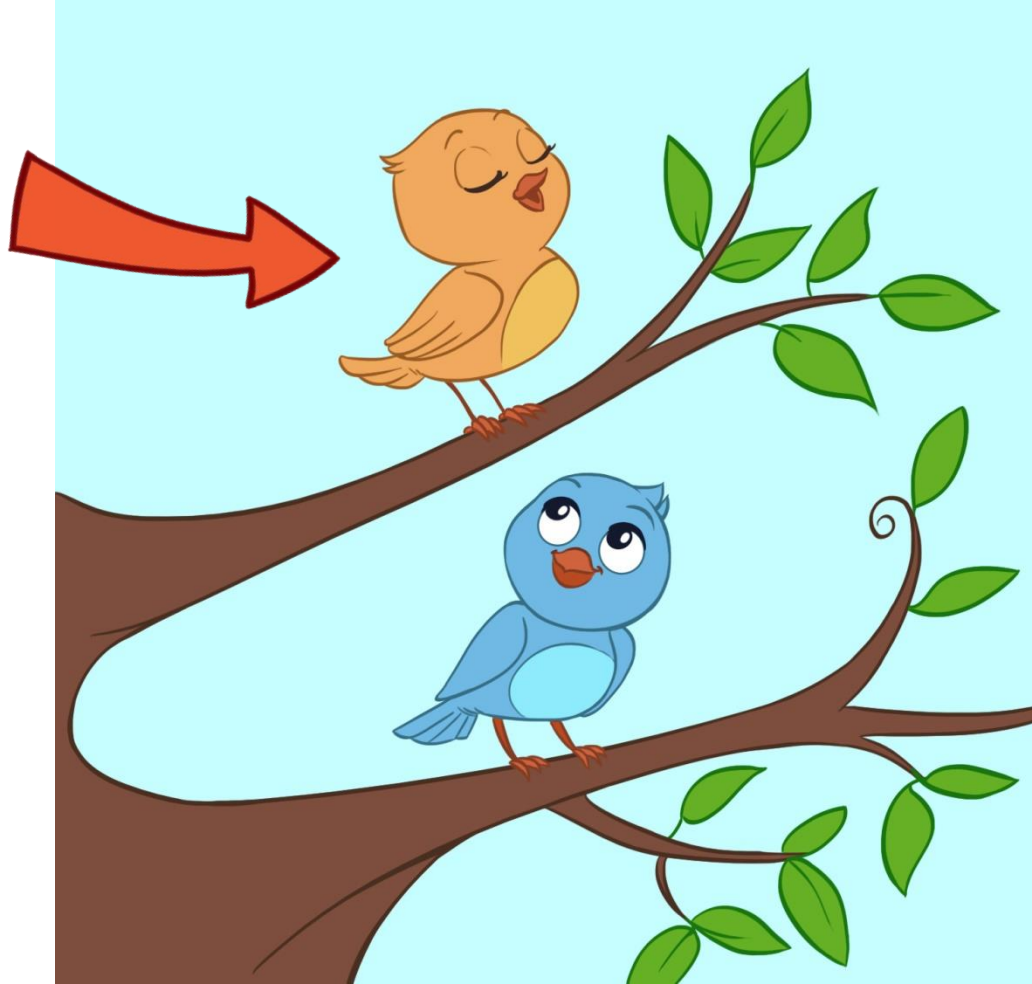



above

Jim sees the stars

_____.







beautiful

"Yes, the stars are
_____, " Jim says.

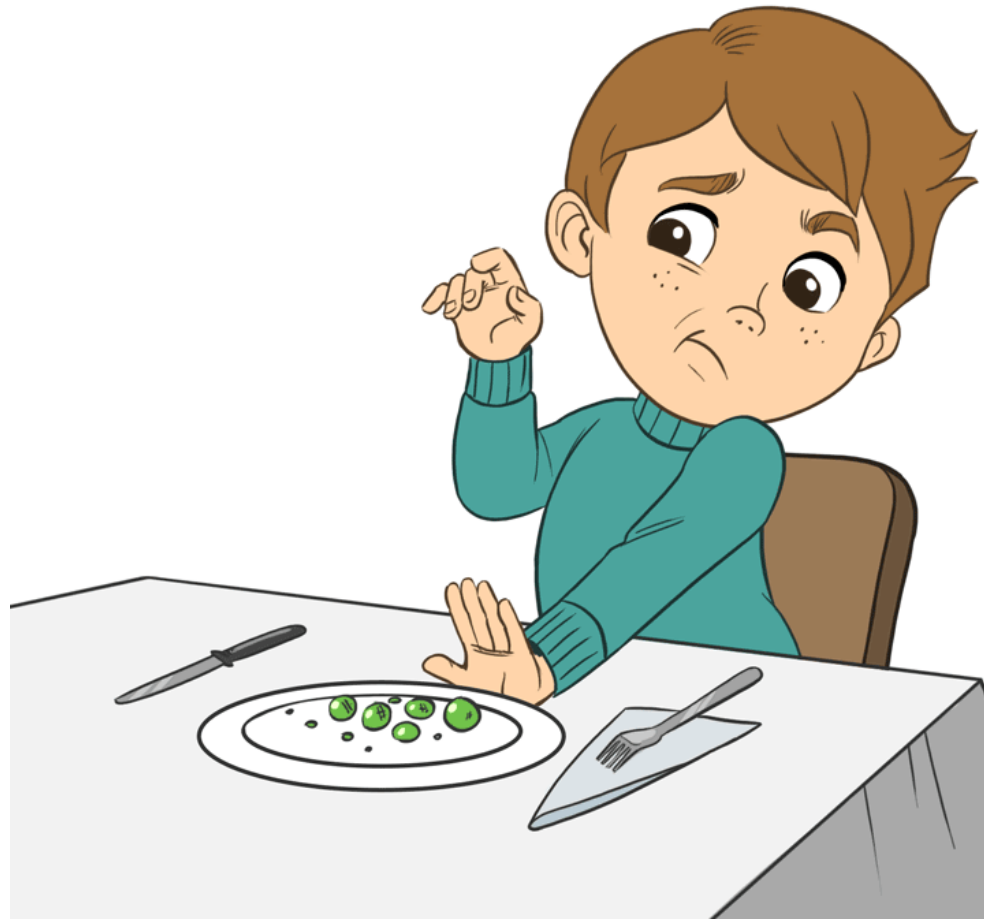



away

Put the peas _____.





old

Dad says the stars are far
away and _____.





young

Jim is _____.

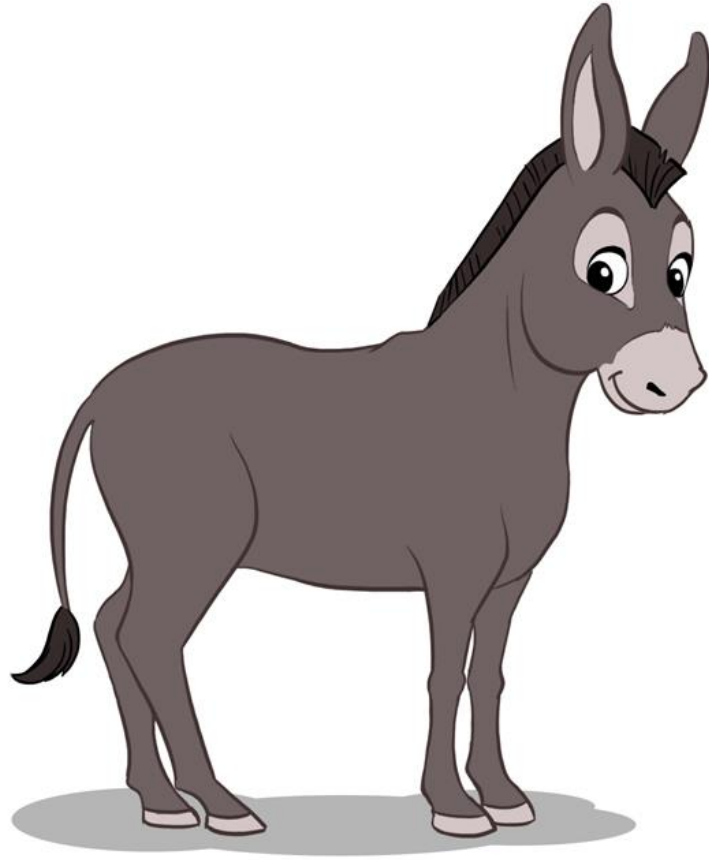



donkey

Fox and _____ were
walking in the desert.





dinner

You will have donkey for

_____.





quietly

“Let me go,” Fox said to
Lion _____.





agree

Lion _____ to let the
fox go.







follow

Donkey _____ Fox.

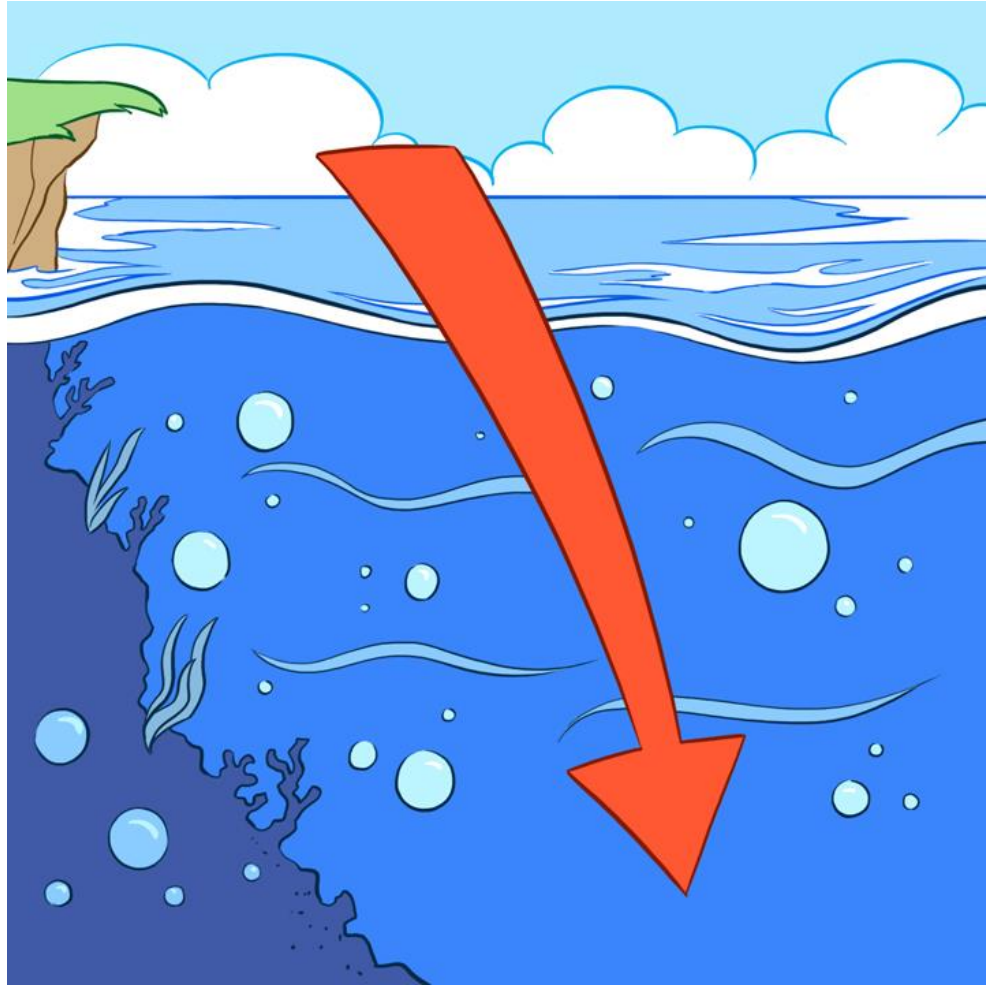



deep

He fell into a _____
hole .





crater

The old _____ had
water in it.



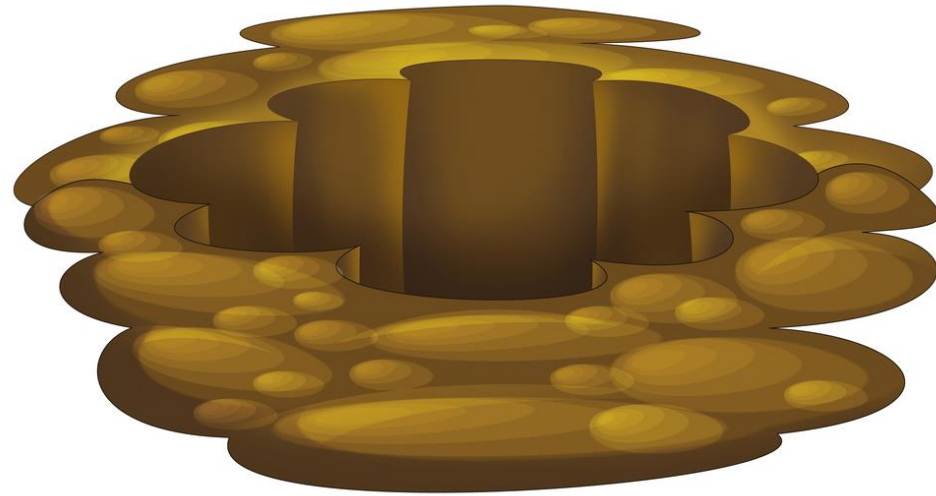



pit

The rabbit fell into a

_____.